



Mi • Light Subordinate New Brand

# 9W RGB+CCT LED Underwater Light

Model No.: UW03

## Product Features

This wall-mounted underwater lamp is designed and developed for underwater lighting; It's with RF module inside. We use LoRa modem technology to fulfill the super long distance controlling. It's controlled by our 433MHz remote control or 433MHz Gateway for smartphone control. The lamp is with Red, Green, blue, cool white and warm white LED chips in side to fulfill the color changing, brightness dimming and dynamic mode controlling. Easy operation.



RGB+CCT  
16 millions of colors to choose



433MHz RF wireless  
transmission technology



Color temperature  
2700~6500K



Super long distance 433MHz  
remote controller control



Dimmable  
saturation control



Smart phone app control  
(433MHz Gateway is needed)



Waterproof and dustproof  
grade IP68

## Dynamic Mode Sheet

Number	Dynamic Mode	Brightness & Speed
1	Mardi Gras	Adjustable
2	Automatic color change	
3	Sam	
4	Gemstone	
5	Twilight	
6	American	
7	Fat Tuesday	
8	Party	
9	Slow Color Splash	

# Parameters

Model No.: UW03

Input Voltage: AC12V / DC12V~24V

Power: 9W

Working Temperature: -20~45°C

Color temperature: 2700~6500K

Luminous Flux: 600LM

Light Efficiency: 75LM/W

CRI: >80

Control distance: 50m (Lamps into 0.5m underwater)

Lifespan: 50000h

IP Rate: IP68

Product Weight: 1.3kg

Housing Material: Aluminum+stainless steel

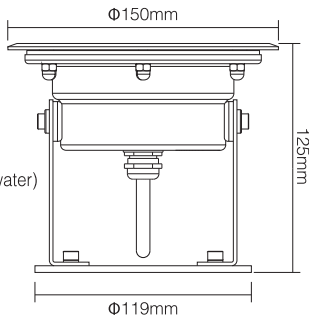

# Connection Diagram

Input: AC12V / DC12V~24V

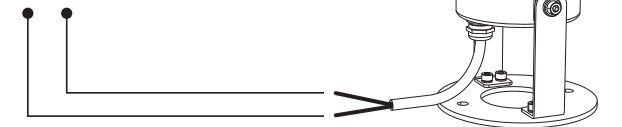

Power input

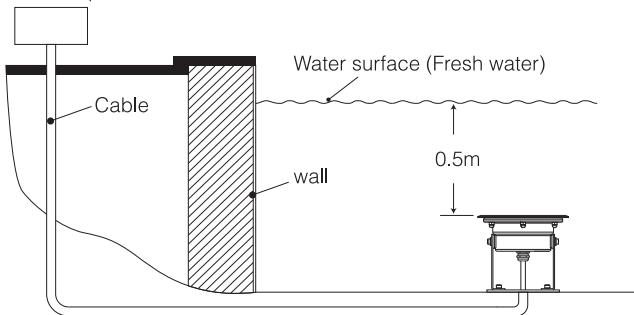

# Link/Unlink

Compatible with "FUT086 remote control" and "WL-433 433MHz gateway"  
(Purchased separately)



Lighting can be working after linking with remote; for more details,  
pls read the remote instruction.

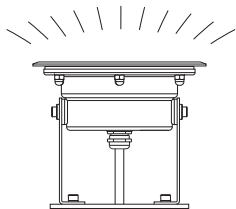

LED Underwater Light

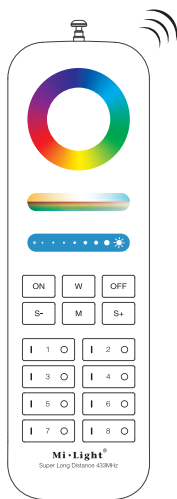

FUT086 433MHz Remote Control

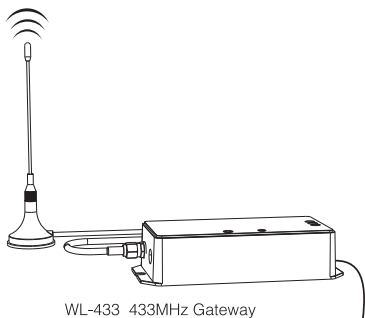

WL-433 433MHz Gateway

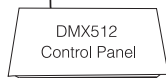

DMX512  
Control Panel

# Switch-OFF to change color instruction

Switch OFF(for 5 seconds); Switch-ON again	Switch-OFF (For 5-10 seconds); Switch ON again	Switch-OFF ( for over 10 seconds); Switch ON again
<b>Switch the colors and dynamic modes in turn</b>  1. Static Red                    9. Mardi Gras 2. Static Green                10. Automatic color change 3. Static Blue                   11. Sam 4. Static Yellow                12. Gemstone 5. Static Cyan                   13. Twilight 6. Static Purple                14. American 7. Static Cool White         15. Fat Tuesday 8. Static Warm White        16. Party 17. Slow Color Splash	Static Red	Status before Switch OFF

## Attention

1. Please check whether the input voltage is in accordance with the lighting working voltage, and please check the connection of both the cathode and anode.
2. The working Voltage is 24V, the lighting will be damage if the voltage is higher than 24V.
3. Non-professional user cannot dismantle the lighting directly, Otherwise it may damage the lighting.
4. The working temperature is -20~45°C.
5. Please do not use lighting around the mental area and high magnetic field, otherwise, it will badly affect the control distance.
6. Users must be correct, strict and solid to install the light; do not use the light on strenuous vibration area.



Made in China