

**MiBOXER<sup>®</sup>**

**Mi • Light Subordinate New Brand**

433MHz Gateway

Model No.: WL-433

Please read the instructions carefully before using the controller.

## 1. Features

Use LoRa SPSP Modem technology, compatible with MiBoxer 433MHz series products; and controlled by MiBoxer APP through WiFi or 4G network. Support DMX512(1990) control. Support third party voice control.



Support Third Party Voice Control



Can control MiBoxer 433MHz series product



WiFi Wireless Control



433MHz RF LoRa SPSP modem technology



Smart phone App control



Support DMX512(1990) control



16 Millions of colors to choose



Color temperature 2700-6500K



Dimmable Saturation control



Timing ON/OFF the lights



One button learning Copy remote ID



## 2. Parameters

Model No.: WL-433

Input: DC5V/500mA ( 5.5\*2.1mm  $\ominus$   $\oplus$  )

Working Temperature: -20~60°C

Communication Mode: WiFi-IEEE 802.11b/g/n 2.4GHz

Input Signal: DMX512(1990)

RF: 433MHz ( Transmitting Power: 15dBm )

Modulation Method: LoRa spread spectrum

Control Distance: 50m (Lamps into 0.5m under freshwater)

Control Distance: 1000m (Lamps on the open area)

Product Weight: 95g

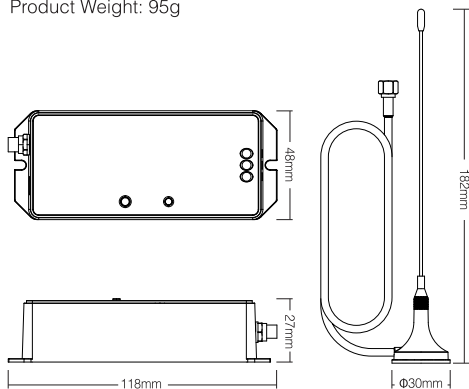

### 3. Installation

Please install the device within 50m as lights, and approaching the WiFi Router.

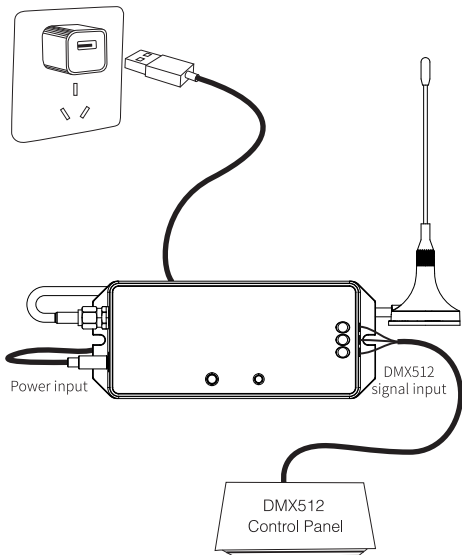

## 4. User Instruction

1. Install MiBoxer APP. Click" + " add devices( See details on MiBoxer APP instructions).
2. Click "433 Gateway" on the device list to enter control interface.
3. Click "Link/Unlink". Link/Unlink method, See details on APP link/unlink instruction.
4. After linking successfully, back to the control interface to control the lights randomly.

**Note:** This gateway cannot group control.

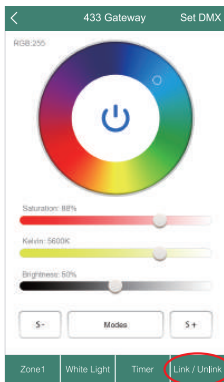
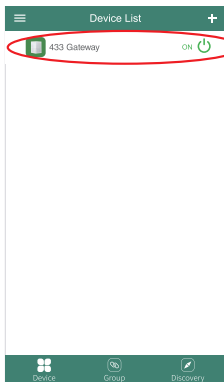

# Learning function:

Gateway copy the remote ID to fulfill the gateway and remote ID no difference; after linking with remote, the gateway can control the lamps directly without linking again.

1. click "Learn" button, device indicating lamp blinking.
- 2, within 10 seconds, click any button on the remote, APP will hint learning successfully.

**Note: Just FUT086 433MHz remote support learning currently.**

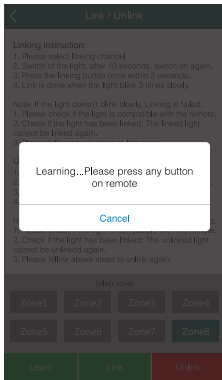
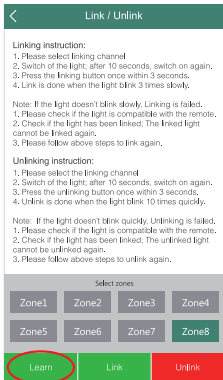

## Restore gateway ID:

Short press gateway "SET" five times; restore successfully after devices indicating lamp blink 3 times.

## Zone selection:

Click the "Zone" on the left bottom into the Zone selection.

**Note:** Please select the linked Zone, otherwise it cannot control the lamps.

## Setting DMX512 address:

Click "Set DMX" on the top right corner; Set DMX512 address for gateway on the pop-up window.

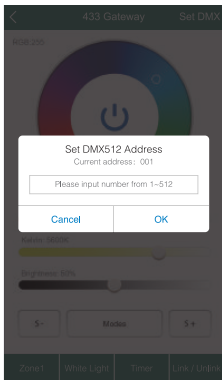
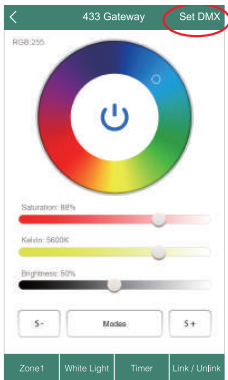

Gateway need to occupy 5 address to control lamp's red,green,blue,warm white and cool white accordingly.

i.e: Set the gateway DMX512 address to 008

Occupied address	008	009	010	011	012
Controlled colors	Red	Green	Blue	Cold white	Warm White

Note: You must link the lamps to the gateway to control the lamps(Linking instruction see details for Miboxer APP Link/Unlink interface).

## Attention

1. The input voltage is DC5V/500mA, Please do not connect the power supply over DC5V, otherwise, the device will be broken easily.
2. Non-professional user cannot dismantle the device directly, otherwise, the device will be broken easily.
3. The working temperature is  $-20\sim 60^{\circ}\text{C}$ ; Do not install the device to direct sunlight, moist and other high temperature area.
4. Please do not install the device around the mental area and high magnetic field, otherwise, it will badly affect the control distance.



Made in China



# MiBoxer APP

## User Instruction

### 1 APP Downloading

**For IOS System:** Pls search "MiBoxer" on APP store. (Above IOS9.0)

**For Android System:** search "MiBoxer" on Google Play (Above Android 5.0) or Scan below QR-code to download APP.



Scan QR Code to Install APP



Download on the  
**App Store**



GET IT ON  
**Google Play**

## 2 Register MiBoxer Account

Open APP and click Register button; Complete the register and log in.

Mobile 10:18 95%

**MIBOXER<sup>®</sup>**  
MI-Light Subordinate New Brand

United Kingdom +44 >

Mobile number / Email address

Password

I agree [Service Agreement](#) and [Privacy Policy](#)

Log in

Register

Authentication code login      Forgot Password

### 3 Add Device

1. Click the right top “+” on the device list.
2. Please select the device type you will add, then complete the adding according to the hint of APP.
3. Back to device list after adding successfully, then pull down refresh in list to get the device status.

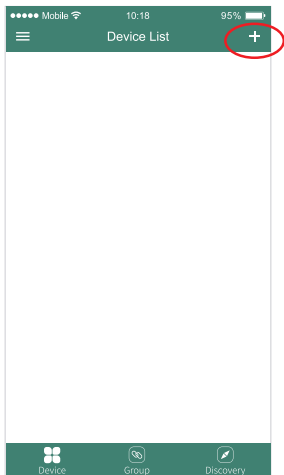



## 4 Modify device name or delete device

Slide device list to left, click " **Edit** " to modify device name; click " **Delete** " to delete device.

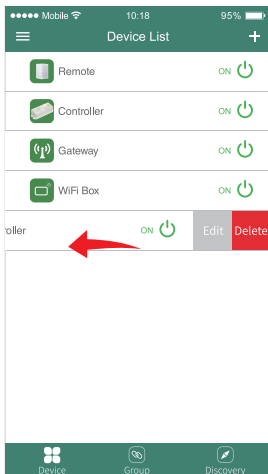
**Note:** If the device was shared to others, then the device will also be deleted on your friends' device list.



## 5 Group Control



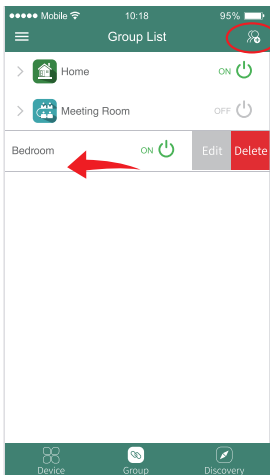

1. Click  to switch to Group list, then click the right top  icon on the Group list to create groups.
2. Slide the Group list to left to **Edit / Delete** groups.

**Note:** The group just work on APP Controlling, cannot work on Voice control. Please open third party APP for Group Voice control.



## 6 APP Control

Click the device or group that you want to dim on device list and group list into Dimming Interface.

-  Click speed+ under dynamic mode.
-  Click speed- under dynamic mode.
-  Sunset mode: Gradually OFF within 10 minutes.
-  Good night mode: Gradually OFF within 1 minute.

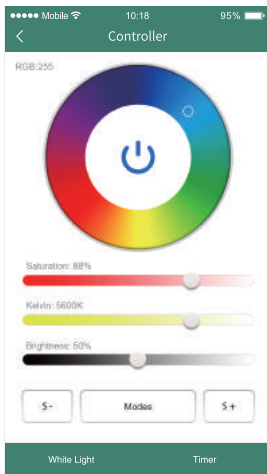

## 7 Third Party Voice Control instructions

Search "Mi-Light Smart" on third-party platform APP and set up.

Click left top "☰" icon on the home page;

Then click "  Voice Control " to check detailed instructions.

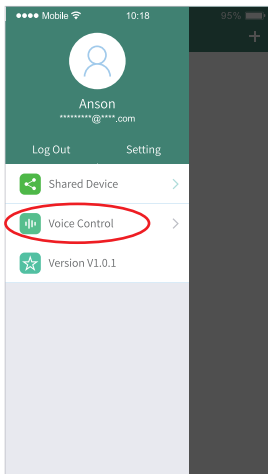

## 8 Sharing Device

Share the device to friends, Let your friends can control this device.

1. Click the left top "☰" icon on the home page.
2. Click "🔙 Shared Device" to My sharing, then click "**Add sharing**" (Note: the receiving sharing device cannot be shared again).
3. Click "👤 Jack jack@milight.com" to edit sharing, slide to left to delete sharing.

