

FUTLIGHT IS LEADER OF SMART LED LIGHTING MANUFACTURER, WE WILL KEEP DOING INNOVATION AND DEVELOP CREATIVE ITEM, STAY TOGETHER WITH ALL DEALERS, IMPROVE BUSINESS IN GLOBAL MARKET.

WE PROVIDE A VARIETY OF TYPES OF LAMPS, REMOTE CONTROLS AND CONTROLLERS TO CHOOSE FROM, WHICH CAN BE USED IN HOME, HOTEL, ROAD LIGHTING ENGINEERING, UNDERWATER DECORATION AND OTHER FIELDS.

		
03 Zigbee 3.0 Gateway	04 Zigbee 3.0 Remote	05-10 Zigbee 3.0 Light

		
28 Triac	29-34 2.4G Light Bulb	35-36 LED Spotlight

		
11-13 LED Controller	14 Waterproof LED Controller	15 5 in 1 LED Controller

		
37-38 COB Downlight	39-41 2.4G LED Downlight	42-46 2.4G LED Garden Light

		
16 Waterproof 5 in 1 LED Controller	17-18 Dimming LED Driver	19-20 High voltage Dimming LED Driver

		
47-51 2.4G LED Floodlight	52 2.4G LED Wall Washer Light	53-58 DMX512 Series

		
21-25 2.4G Remote	26 2.4G Gateway	27 Amplifier

		
59-62 DALI Series	63-66 SYS Series	67-72 LoRa Series

Zigbee 3.0 Gateway

The product follows the standard protocol of Zigbee 3.0.

Through the Tuya Smart app, user can add Zigbee device, group control, remote control, and third-party voice control to meet smart home and other applications.

- Do not disturb mode
- Support zigbee 3.0 product series
- Support smartphone app control
- Sleep/wakeup plan
- Device sharing
- Timing setting
- Support music rhythm
- group control
- Biorhythm
- Support long-range control
- Support third party voice control
- Scene customization
- Tap-to-Run & automation

Zigbee 3.0 Wireless Gateway

Integrate WiFi and Zigbee communication methods.

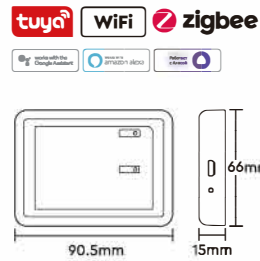

Model	Input Voltage	Wireless Technology	Transmitting Power	Working Temp.	Connected Device	Zigbee Control Distance
ZB-Box1	DC5V/1A (Micro USB)	WiFi 802.11 b/g/n (Zigbee 802.15.4)	WiFi 20dBm ZigBee 10dBm	-10~40°C	Max 50	100m (open area)

Zigbee 3.0 Wired Gateway

Zigbee device connect with network based on this gateway and communicate with other device. Zigbee gateway connect with router via network cable to achieve communication between cloud and smartphone app.

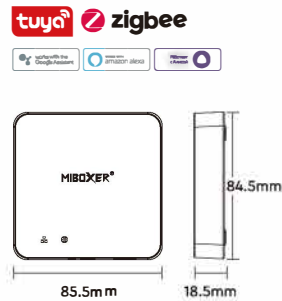

Model	Input Voltage	Wireless Technology	Transmitting Power	Working Temp.	Connected Device	Zigbee Control Distance
ZB-Box2	DC5V/1A (Micro USB)	Zigbee 802.15.4	ZigBee 10dBm	-10~40°C	Max 128	100m (open area)

Zigbee 3.0 Remote

This item is made by zigbee 3.0 standard protocol with low consumption, strong ability to set up internet and anti-interference. It can control on/off, RGB color, color temperature, saturation and brightness for Zigbee 3.0 lights (Zigbee 3.0 gateway is needed). One remote device can control max 25 lights.



- 16 Millions of colors to choose
- Color temperature adjustable
- Dim brightness / Saturation
- Group Number 7 Zones
- Compatible with all zigbee 3.0 lights
- Remote to control lights (Zigbee 3.0 gateway is needed)

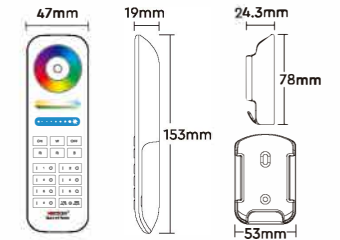

Model	Working Voltage	Standby Power Consumption	Transmitting Power	Working Temp.	Controllable Lights	Control Distance
FUT089Z	3V(AAA * 2PCS)	20µA	10dBm	-10~40°C	Max 25 Pcs	100m (open area)



Zigbee 3.0 LED Light Bulb/Spotlight



Bulbs always used in smart home decoration, zigbee bulbs support network and communicate with other zigbee device, smart and automatic home for your life.

- 16 Millions of colors to choose
- Color temp., Dim brightness
- Saturation adjustable.
- Zigbee 3.0 remote control (Zigbee 3.0 gateway is needed)



12W RGB+CCT LED Bulb (Zigbee 3.0)

Color Temp.: 2700K~6500K
Working Temp.: -10~40°C
PF: >0.5
CRI: >80
Lifespan: 50000h
Base Type: E26 / E27 / B22



12W
1100LM



Model	Input Voltage	Power	Luminous Efficiency	Beam Angle	Control Distance
FUT105Z	100-240V~ 50/60Hz	12W	90LM/W	220°	100m(open area)

4W GU10 RGB+CCT LED Spotlight (Zigbee 3.0)

Color Temp.: 2700K~6500K
Working Temp.: -10~40°C
PF: >0.55
CRI: >80
Lifespan: 50000h
Base Type: GU10



4W
320LM



Model	Input Voltage	Power	Luminous Efficiency	Beam Angle	Control Distance
FUT103Z	100-240V~ 50/60Hz	4W	80LM/W	25°	100m(open area)

6W GU10 RGB+CCT LED Spotlight (Zigbee 3.0)

Color Temp.: 2700K~6500K
Working Temp.: -10~40°C
PF: >0.55
CRI: >80
Lifespan: 50000h
Base Type: GU10

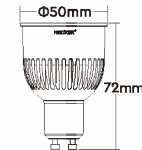

6W
550LM



Model	Input Voltage	Power	Luminous Efficiency	Beam Angle	Control Distance
FUT106Z	100-240V~ 50/60Hz	6W	90LM/W	30°	100m(open area)

Zigbee 3.0 LED Downlight

Downlight usually used in commercial office, shopping mall, restaurant. Zigbee protocol make everything to be simply connection. Create and decorate best luminous in anywhere.

- 16 Millions of colors to choose
- Color temp., Dim brightness
- Saturation adjustable.
- Zigbee 3.0 remote control (Zigbee 3.0 gateway is needed)



6W RGB+CCT LED Downlight (Zigbee 3.0)

Color Temp.: 2700K~6500K
Working Temp.: -10~40°C
PF: >0.5
CRI: >80
Lifespan: 50000h
Material: Aluminum+PC Cover



Hole Size: Φ 90-95mm

6W
600LM



Model	Input Voltage	Power	Luminous Efficiency	Beam Angle	Control Distance
FUT068Z	100-240V~ 50/60Hz	6W	100LM/W	120°	100m(open area)

12W RGB+CCT LED Downlight (Zigbee 3.0)

Color Temp.: 2700K~6500K
Working Temp.: -10~40°C
PF: >0.5
CRI: >80
Lifespan: 50000h
Material: Aluminum+PC Cover



Hole Size: Φ 145-150mm

12W
1100LM



Model	Input Voltage	Power	Luminous Efficiency	Beam Angle	Control Distance
FUT066Z	100-240V~ 50/60Hz	12W	90LM/W	120°	100m(open area)

Zigbee 3.0

Magnetic Grille Light / Magnetic Floodlight

Newest arrival, support din rail installation, moveable and foldable. Flexible for various lighting application

- Color temperature adjustable
- Dim brightness
- Zigbee 3.0 remote control (Zigbee 3.0 gateway is needed)

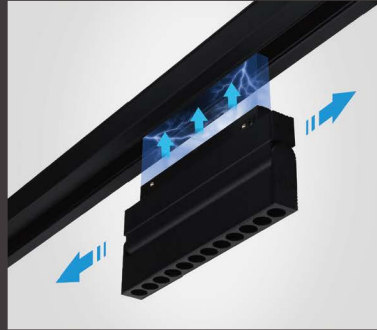

NEW

Foldable Magnetic Grille Light (Zigbee 3.0)



Color Temp.: 2700K~6500K
Working Temp.: -10~40°C
CRI: >80
Lifespan: 50000h

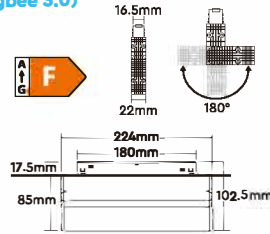

Model	Type	Input Voltage	Power	Luminous Efficiency	Luminous Flux	Beam Angle	Control Distance
MG5-06F-ZL	RGB+CCT	48V~	6W	65LM/W	440LM	24°	50m (open area)
MG2-10F-ZL	Dual White		10W	80LM/W	800LM		

NEW

Foldable Magnetic Grille Light (Zigbee 3.0)



Color Temp.: 2700K~6500K
Working Temp.: -10~40°C
CRI: >80
Lifespan: 50000h

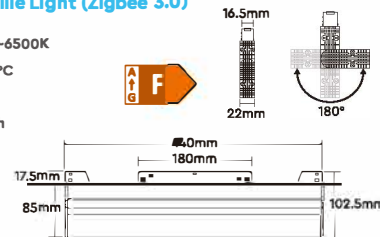

Model	Type	Input Voltage	Power	Luminous Efficiency	Luminous Flux	Beam Angle	Control Distance
MG5-12F-ZL	RGB+CCT	48V~	12W	75LM/W	900LM	24°	50m (open area)
MG2-20F-ZL	Dual White		20W	75LM/W	1530LM		

NEW

Magnetic Grille Light (Zigbee 3.0)



Color Temp.: 2700K~6500K
Working Temp.: -10~40°C
CRI: >80
Lifespan: 50000h

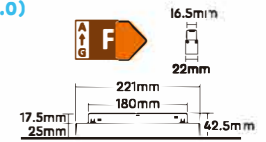

Model	Type	Input Voltage	Power	Luminous Efficiency	Luminous Flux	Beam Angle	Control Distance
MG5-06N-ZL	RGB+CCT	48V~	6W	65LM/W	440LM	24°	50m (open area)
MG2-10N-ZL	Dual White		10W	80LM/W	800LM		

NEW

Magnetic Grille Light (Zigbee 3.0)



Color Temp.: 2700K~6500K
Working Temp.: -10~40°C
CRI: >80
Lifespan: 50000h



Model	Type	Input Voltage	Power	Luminous Efficiency	Luminous Flux	Beam Angle	Control Distance
MG5-12N-ZL	RGB+CCT	48V~	12W	75LM/W	900LM	24°	50m (open area)
MG2-20N-ZL	Dual White		20W	75LM/W	1530LM		

NEW

Magnetic Floodlight (Zigbee 3.0)



Color Temp.: 2700K~6500K
Working Temp.: -10~40°C
CRI: >80
Lifespan: 50000h

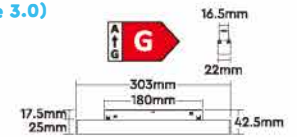

Model	Type	Input Voltage	Power	Luminous Efficiency	Luminous Flux	Beam Angle	Control Distance
MF5-12A-ZL	RGB+CCT	48V~	12W	40LM/W	450LM	120°	50m (open area)
MF2-12A-ZL	Dual White		12W	45LM/W	500LM		

NEW

Magnetic Floodlight (Zigbee 3.0)



Color Temp.: 2700K~6500K
Working Temp.: -10~40°C
CRI: >80
Lifespan: 50000h



Model	Type	Input Voltage	Power	Luminous Efficiency	Luminous Flux	Beam Angle	Control Distance
MF5-24A-ZL	RGB+CCT	48V~	24W	40LM/W	900LM	120°	50m (open area)
MF2-24A-ZL	Dual White		24W	45LM/W	950LM		

NEW



6W RGB+CCT LED Garden Light (Zigbee 3.0)

Model: FUTC04Z
 Input: 100-240V~ 50/60Hz
 Light Efficiency: 90LM/W
 Color Temp.: 2700K~6500K
 CRI: >80
 PF: >0.5
 Beam Angle: 25°
 Working Temp.: -20~45°C
 Control Distance: 100m(open area)
 Illumination Distance: >10m
 Lifespan: 50000h



6W
550LM

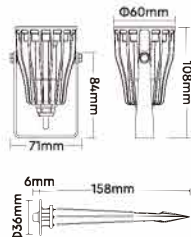

NEW



9W RGB+CCT LED Garden Light (Zigbee 3.0)

Model: FUTC02Z
 Input: 100-240V~ 50/60Hz
 Light Efficiency: 100LM/W
 Color Temp.: 2700K~6500K
 CRI: >80
 PF: >0.5
 Beam Angle: 15°
 Working Temp.: -20~45°C
 Control Distance: 100m(open area)
 Illumination Distance: >10m
 Lifespan: 50000h



9W
900LM

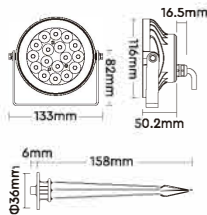

NEW



15W RGB+CCT LED Garden Light (Zigbee 3.0)

Model: FUTC03Z
 Input: 100-240V~ 50/60Hz
 Light Efficiency: 100LM/W
 Color Temp.: 2700K~6500K
 CRI: >80
 PF: >0.5
 Beam Angle: 15°
 Working Temp.: -20~45°C
 Control Distance: 100m(open area)
 Illumination Distance: >10m
 Lifespan: 50000h



15W
1500LM

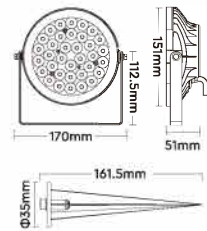

NEW



25W RGB+CCT LED Garden Light (Zigbee 3.0)

Model: FUTC05Z
 Input: 100-240V~ 50/60Hz
 Light Efficiency: 88LM/W
 Color Temp.: 2700K~6500K
 CRI: >80
 PF: >0.5
 Beam Angle: 15°
 Working Temp.: -20~45°C
 Control Distance: 100m(open area)
 Illumination Distance: >15m
 Lifespan: 50000h



25W
2200LM

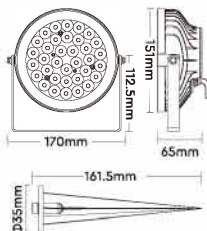

Zigbee 3.0 LED Floodlight

Floodlight often be used for architectural lighting, in garden area. Zigbee protocol support long distance and more intelligent.

- 16 Millions of colors to choose
- Color temp., Dim brightness
- Saturation adjustable.
- Zigbee 3.0 remote control (Zigbee 3.0 gateway is needed)



NEW



50W RGB+CCT LED Floodlight (Zigbee 3.0)

Model: FUTT02Z
 Input: 100-240V~ 50/60Hz
 Light Efficiency: 96LM/W
 Color Temp.: 2700K~6500K
 CRI: >80
 PF: >0.9
 Beam Angle: 160°
 Working Temp.: -20~45°C
 Control Distance: 100m (open area)
 Illumination Distance: >25m
 Lifespan: 50000h



50W
4800LM

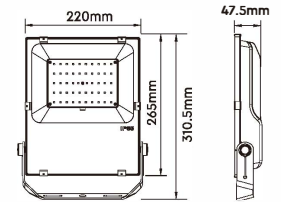

NEW



30W RGB+CCT LED Floodlight (Zigbee 3.0)

Model: FUTT03Z
 Input: 100-240V~ 50/60Hz
 Light Efficiency: 110LM/W
 Color Temp.: 2700K~6500K
 CRI: >80
 PF: >0.9
 Beam Angle: 160°
 Working Temp.: -20~45°C
 Control Distance: 100m (open area)
 Illumination Distance: >18m
 Lifespan: 50000h



30W
3300LM

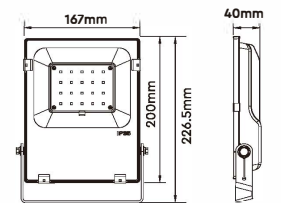



LED CONTROLLER SERIES

LED CONTROLLER



WIFI+2.4G LED CONTROLLER

2.4G RF technology, low power consumption, built-in WiFi chip, support app control or third party voice control directly (no need 2.4GHz Gateway), 100% compatible with Tuya Smart app.



FUT035W	WiFi+2.4G Dual White
FUT036W	WiFi+2.4G Single Color
FUT037W	WiFi+2.4G RGB
FUT038W	WiFi+2.4G RGBW
FUT039W	WiFi+2.4G RGB+CCT

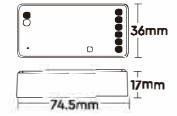

Model	Input Voltage	Total Output	Working Temp.	Control Method	Remote Control Distance
FUT035W - FUT039W	DC12V~24V	Max 12A	-10~40°C	WiFi+2.4G	30m



2.4G (HIGH CURRENT) LED CONTROLLER

Max 20A current output with high power, 2.4G RF technology, low power consumption, more powerful for special application, App control and third party voice control need 2.4GHz Gateway (Model: WL-Box1)



FUT035P	2.4G Dual White
FUT036P	2.4G Single Color
FUT037P	2.4G RGB
FUT038P	2.4G RGBW
FUT039P	2.4G RGB+CCT

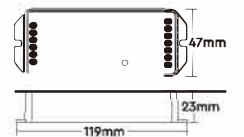

Model	Input Voltage	Total Output	Working Temp.	Control Method	Remote Control Distance
FUT035P - FUT039P	DC12V~48V	Max20A	-10~40°C	2.4G	30m



Zigbee 3.0 LED CONTROLLER

ZigBee 3.0 is most notable for bringing together all of the various Zigbee environments into a single unified standard.



FUT035Z	Zigbee 3.0 Dual White
FUT036Z	Zigbee 3.0 Single Color
FUT037Z	Zigbee 3.0 RGB
FUT038Z	Zigbee 3.0 RGBW
FUT039Z	Zigbee 3.0 RGB+CCT

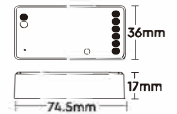

Model	Input Voltage	Total Output	Working Temp.	Control Method	Remote Control Distance
FUT035Z - FUT039Z	DC12V~24V	Max 12A	-10~40°C	Zigbee 3.0	100m(open area)

Note:

1. Colourful RGB type support 18 dynamic mode, dim saturation and 16 millions colors, dynamic mode auto transmitting and synchronized
2. RGB+CCT type support DMX512 control, need to pair with FUTD01 (Except for Zigbee 3.0 controllers)



Ultra-thin and stylish main body, cheapest and economic type, wide application and top selling series, 2.4G RF technology, App control and third party voice control need 2.4GHz Gateway (Model: WL-Box1)



FUT035S	2.4G Dual White
FUT036S	2.4G Single Color
FUT037S	2.4G RGB
FUT038S	2.4G RGBW
FUT039S	2.4G RGB+CCT

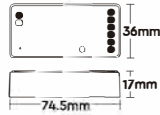

Model	Input Voltage	Total Output	Working Temp.	Control Method	Remote Control Distance
FUT035S ~ FUT039S	DC12V~24V	Max 12A	-10~40°C	2.4G	30m



2.4G Controller kits: (S type controller + Sunrise or Rainbow remote) save money, cheaper than you purchase controller and remote separately.

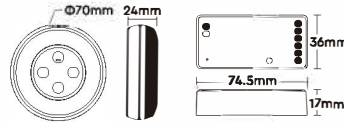

FUT035SA	FUT035S	Sunrise Remote (S1-W)
FUT036SA	FUT036S	
FUT037SA	FUT037S	Rainbow Remote (S2-W)
FUT038SA	FUT038S	
FUT039SA	FUT039S	

Product	Input Voltage	Total Output	Working Temp.	Control Method	Remote Control Distance
Controller	DC12V~24V	Max 12A	-10~40°C	2.4G	30m

Product	Working Voltage	Standby Power	RF	Control Distance
Remote	3V(AAA * 2PCS)	15μA	2.4GHz	30m

Note:

1. Colourful RGB type support 18 dynamic mode, dim saturation and 16 millions colors, dynamic mode auto transmitting and synchronized
2. RGB+CCT type support DMX512 control (need to pair with FUTD01)

WATERPROOF LED CONTROLLER



LED Controller has wide application in outdoor lighting, below controller series are "PLUS Version" for FUT035W-FUT039W. White and black appearance, simple and high-grade design. Built-in wifi chip, IP66 version. The cable length is 25cm with naked wire.



FUT035W-P	WiFi+2.4G Dual White
FUT036W-P	WiFi+2.4G Single Color
FUT037W-P	WiFi+2.4G RGB
FUT038W-P	WiFi+2.4G RGBW
FUT039W-P	WiFi+2.4G RGB+CCT

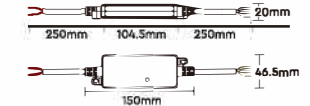

Model	Input Voltage	Total Output	Working Temp.	Control Method	Remote Control Distance
FUT035W-P ~ FUT039W-P	DC12V~24V	Max 12A	-20~45°C	WiFi+2.4G	30m



LED Controller has wide application in outdoor lighting, below controller series are "PLUS Version" for FUT035S-FUT039S. White and black appearance, simple and high-grade design, IP66 version. The cable length is 25cm with naked wire.



FUT035S-P	2.4G Dual White
FUT036S-P	2.4G Single Color
FUT037S-P	2.4G RGB
FUT038S-P	2.4G RGBW
FUT039S-P	2.4G RGB+CCT

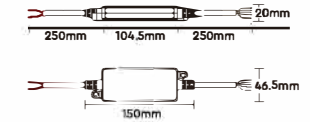

Model	Input Voltage	Total Output	Working Temp.	Control Method	Remote Control Distance
FUT035S-P ~ FUT039S-P	DC12V~24V	Max 12A	-20~45°C	2.4G	30m



LED Controller has wide application in outdoor lighting, below controller series are "PLUS Version" for FUT035Z-FUT039Z. White and black appearance, simple and high-grade design. Built-in zigbee 3.0 chip, IP66 version. The cable length is 25cm with naked wire.



FUT035Z-P	Zigbee 3.0 Dual White
FUT036Z-P	Zigbee 3.0 Single Color
FUT037Z-P	Zigbee 3.0 RGB
FUT038Z-P	Zigbee 3.0 RGBW
FUT039Z-P	Zigbee 3.0 RGB+CCT

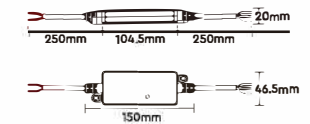

Model	Input Voltage	Total Output	Working Temp.	Control Method	Remote Control Distance
FUT035Z-P ~ FUT039Z-P	DC12V~24V	Max 12A	-20~45°C	Zigbee 3.0	100m(open area)

Note:

1. Colourful RGB type support 18 dynamic mode, dim saturation and 16 millions colors, dynamic mode auto transmitting and synchronized
2. RGB+CCT type support DMX512 control, need to pair with FUTD01 (Except for Zigbee 3.0 waterproof controllers)

5 in 1 controller: (one controller supports five different strip lights --Single color/Dual white/RGB/RGBW/RGB+CCT)
Spend money one time to enjoy five different dimming function, user select output mode randomly based on the feature of strip light.

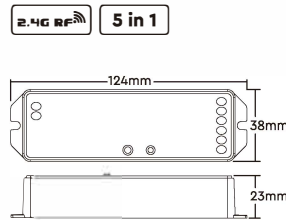

Model	Input Voltage	Output	Total Output	Working Temp.	Control Method	Remote Control Distance
LS2	DC12V~24V	6A/Channel	Max 15A	-20~60°C	2.4G	30m

Main function is same as above LS2 controller (5 in 1 type), the main difference is that current WL5 is built-in WiFi chip, support app or third voice control directly without connection with 2.4GHz Gateway (Model: WL-Box1)

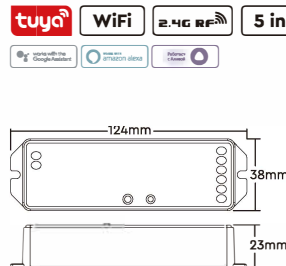

Model	Input Voltage	Output	Total Output	Working Temp.	Control Method	Remote Control Distance
WL5	DC12V~24V	6A/Channel	Max 15A	-20~60°C	WiFi+2.4G	30m

Difference between LS2 & WL5

LS2 need WiFi bridge while using app, WL5 is built-in WiFi chip, support app control directly.

WATERPROOF 5 IN 1 LED CONTROLLER

For outdoor application, IP67 waterproof

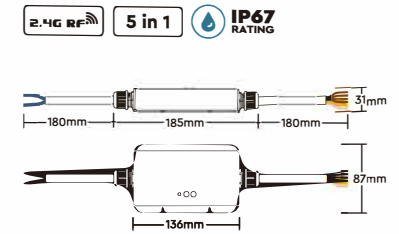

Model	Input Voltage	Output	Total Output	Working Temp.	Control Method	Remote Control Distance
LS2-WP	DC12V~36V	6A/Channel	Max 20A	-20~45°C	2.4G	30m

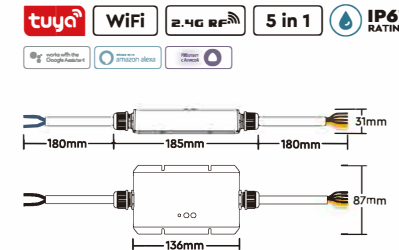

Model	Input Voltage	Output	Total Output	Working Temp.	Control Method	Remote Control Distance
WL5-WP	DC12V~36V	6A/Channel	Max 20A	-20~45°C	WiFi+2.4G	30m

Difference between LS2-WP & WL5-WP

LS2-WP need 2.4GHz Gateway, WL5-WP don't need it while using app.

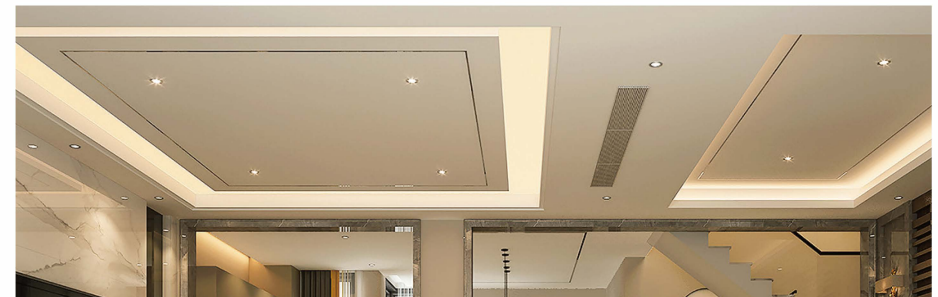

DIMMING LED DRIVER

- Built-in 75W power supply
- More convenient for installation
- Plug in and play, no need to connect extra power supply



Many end users have doubt about power supply connection with Miboxer controller, these led driver will solve all problems, built-in 75w high efficiency power supply, plug in and play, simple and convenient control system.



WL1-P75V24	WiFi+2.4G Single Color
WL2-P75V24	WiFi+2.4G Dual White
WL3-P75V24	WiFi+2.4G RGB
WL4-P75V24	WiFi+2.4G RGBW
WL5-P75V24	WiFi+2.4G RGB+CCT

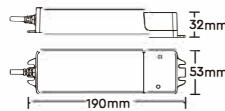

Model	Power	Input Voltage	Output Voltage	Output Current	Working Temp.	Control Method	Remote Control Distance
WL1-P75V24 WL5-P75V24	75W	100-240V~ 50/60Hz	24V---	Max 3A	ta 40°C tc 85°C	WiFi+2.4G	30m



150W power supply will meet more demand for power, we designed them for outdoor application, it's IP67 and very convenient for outdoor lighting. The lighting power source is hard to do connection, once you have our controller, simple and fast solution.



WP1-P150V24	WiFi+2.4G Single Color
WP2-P150V24	WiFi+2.4G Dual White
WP3-P150V24	WiFi+2.4G RGB
WP4-P150V24	WiFi+2.4G RGBW
WP5-P150V24	WiFi+2.4G RGB+CCT

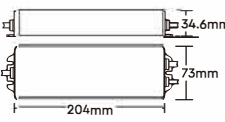

Model	Power	Input Voltage	Output Voltage	Output Current	Working Temp.	Control Method	Remote Control Distance
WP1-P150V24 WP5-P150V24	150W	100-240V~ 50/60Hz	24V---	Max 6.25A	ta 40°C tc 85°C	WiFi+2.4G	30m

Note:

- Both of them are built-in wifi chip, support app control directly.
- Tuya smart is compatible with them, third voice party control (Alexa, Echo, google home)



75W 2.4G DIMMING LED DRIVER

Comparing with WL1-P75 series, CL1-P75 series don't have wifi chip, economic type, the rest functions are same.



CL1-P75V24	2.4G Single Color
CL2-P75V24	2.4G Dual White
CL3-P75V24	2.4G RGB
CL4-P75V24	2.4G RGBW
CL5-P75V24	2.4G RGB+CCT

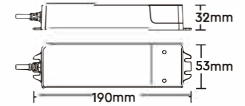

Model	Power	Input Voltage	Output Voltage	Output Current	Working Temp.	Control Method	Control Distance
CL1-P75V24 CL5-P75V24	75W	100-240V~ 50/60Hz	24V---	Max 3A	ta 40°C tc 85°C	2.4G	30m



60W 2.4G DIMMING LED DRIVER

These controller are developed for Miboxer SL1-12 ~ SL4-12 spotlight series, special controller solve all problem while doing installation



CL1-P60V12	2.4G Single Color
CL2-P60V12	2.4G Dual White
CL3-P60V12	2.4G RGB
CL4-P60V12	2.4G RGBW
CL5-P60V12	2.4G RGB+CCT

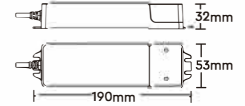

Model	Power	Input Voltage	Output Voltage	Output Current	Working Temp.	Control Method	Control Distance
CL1-P60V12 CL5-P60V12	60W	100-240V~ 50/60Hz	12V---	Max 5A	ta 40°C tc 85°C	2.4G	30m

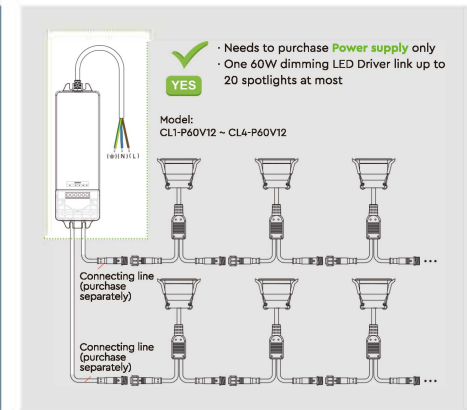

Note:

- Colourful RGB type support 18 dynamic mode, dim saturation and 16 millions colors, dynamic mode auto transmitting and synchronized
- RGB+CCT type support DMX512 control (need to pair with FUTD01)

HIGH VOLTAGE DIMMING LED DRIVER

- Safety
- Reliable
- For outdoor project



Single Color Dimming LED Driver (High Voltage)



- Working Temp.: -10~40°C
- Storage Temp.: -40~80°C
- Working Humidity: 20~95%RH, non-condensing
- Overload Protection: limited power

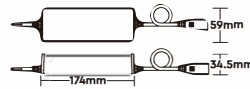

Model	Input Voltage	Output Voltage	Output Current	Rated Power	Efficiency	Control Method	Control Distance
HF1-P400V220	220-240V~ 50/60Hz	220V~	Max 1.82A	Max 400W	94%	2.4G	30m



Dual White Dimming LED Driver (High Voltage)



- Working Temp.: -10~40°C
- Storage Temp.: -40~80°C
- Working Humidity: 20~95%RH, non-condensing
- Overload Protection: limited power

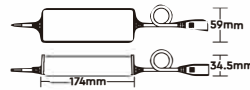

Model	Input Voltage	Output Voltage	Output Current	Rated Power	Efficiency	Control Method	Control Distance
HF2-P400V220	220-240V~ 50/60Hz	220V~	Max 1.82A	Max 400W	94%	2.4G	30m



RGB Dimming LED Driver (High Voltage)



- Working Temp.: -10~40°C
- Storage Temp.: -40~80°C
- Working Humidity: 20~95%RH, non-condensing
- Overload Protection: limited power

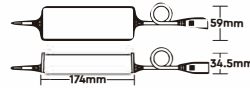

Model	Input Voltage	Output Voltage	Output Current	Rated Power	Efficiency	Control Method	Control Distance
HF3-P400V210	220-240V~ 50/60Hz	210V~	Max 1.9A	Max 400W	94%	2.4G	30m

Note:

1. Be careful while doing connection with high voltage
2. There are many different high voltage led strip on the market, the cable wiring diagram are different, some strip won't be compatible with controller, Miboxer programmed current controller, all end user can use remote to select correct output mode (check instruction), more powerful and universal for all high voltage strip lights from different manufacturer.





2.4G REMOTE SERIES

Single Color



Touch Dimming Remote

Model	FUT087	FUT087-B
Color	White	Black

Working Voltage: 3V(AAA * 2PCS)
Standby Power: 15µA
Size(mm): Ø80 * 17

RF: 2.4GHz
Control Distance: 30m

RGB+CCT



Full Touch RGB+CCT Remote

Model	FUT088
Color	White

Working Voltage: 3V(AAA * 2PCS)
Standby Power: 15µA
Size(mm): 47 * 16.5 * 134

RF: 2.4GHz
Control Distance: 30m

RGB+CCT



8-Zone RGB+CCT Remote

Model	FUT089	FUT089-B
Color	White	Black

Working Voltage: 3V(AAA * 2PCS)
Standby Power: 15µA
Group Number: 8-Zone

RF: 2.4GHz
Control Distance: 30m
Size(mm): 47 * 19 * 153

RGB+CCT



4-Zone RGB+CCT Remote

Model	FUT092	FUT092-B
Color	White	Black

Working Voltage: 3V(AAA * 2PCS)
Standby Power: 20µA
Group Number: 4-Zone

RF: 2.4GHz
Control Distance: 30m
Size(mm): 56 * 20 * 138

RGBW



4-Zone RGBW Remote

Model	FUT095
Color	White

Working Voltage: 3V(AAA * 2PCS)
Standby Power: 15µA
Group Number: 4-Zone

RF: 2.4GHz
Control Distance: 30m
Size(mm): 52.5 * 21 * 120

RGBW



4-Zone RGBW Remote

Model	FUT096	FUT096-B
Color	White	Black

Working Voltage: 3V(AAA * 2PCS)
Standby Power: 15µA
Group Number: 4-Zone

RF: 2.4GHz
Control Distance: 30m
Size(mm): 52.5 * 21 * 120

Dual White



4-Zone Dual White Remote (Rotating Wheel)

Model	FUT006
Color	White

Working Voltage: 3V(AAA * 2PCS) **RF:** 2.4GHz
Standby Power: 15µA **Control Distance:** 30m
Group Number: 4-Zone **Size(mm):** 53 * 21 * 110.5

Dual White



4-Zone Dual White Remote (Full Button)

Model	FUT007
Color	White

Working Voltage: 3V(AAA * 2PCS) **RF:** 2.4GHz
Standby Power: 5µA **Control Distance:** 30m
Group Number: 4-Zone **Size(mm):** 53 * 21 * 110.5

RGB+CCT



Rainbow Remote

Model	S2-W	S2-B	S2-G
Color	White	Black	Grey

Working Voltage: 3V(AAA * 2PCS) **RF:** 2.4GHz
Standby Power: 15µA **Control Distance:** 30m
Size(mm): Ø70 * 24

Dual White



Sunrise Remote

Model	S1-W	S1-B	S1-G
Color	White	Black	Grey

Working Voltage: 3V(AAA * 2PCS) **RF:** 2.4GHz
Standby Power: 15µA **Control Distance:** 30m
Size(mm): Ø70 * 24

RGB+CCT



8-Zone RGB+CCT Panel Remote

Model	B8
Color	White

Working Voltage: 3V(AAA*2PCS)/DC3.3V **RF:** 2.4GHz
Standby Power: 20µA **Control Distance:** 30m
Group Number: 8-Zone **Size(mm):** 106 * 146 * 20

RGB+CCT



RGB+CCT Panel Remote

Model	B0	B0-B
Color	White	Black

Working Voltage: 3V(AAA * 2PCS) **RF:** 2.4GHz
Standby Power: 15µA **Control Distance:** 30m
Size(mm): 86 * 86 * 16

Single Color



4-Zone Single Color Panel Remote

Model	B1	B1-B
Color	White	Black

Working Voltage: 3V(AAA * 2PCS) **RF:** 2.4GHz
Standby Power: 15µA **Control Distance:** 30m
Group Number: 4-Zone **Size(mm):** 86 * 86 * 16

Dual White

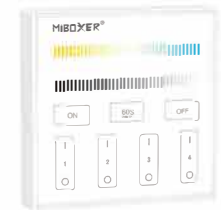

4-Zone Dual White Panel Remote

Model	B2
Color	White

Working Voltage: 3V(AAA * 2PCS) **RF:** 2.4GHz
Standby Power: 15µA **Control Distance:** 30m
Group Number: 4-Zone **Size(mm):** 86 * 86 * 16

RGBW

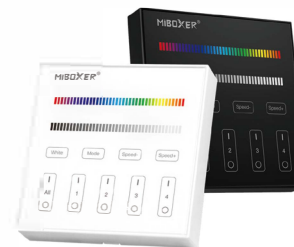

4-Zone RGBW Panel Remote

Model	B3	B3-B
Color	White	Black

Working Voltage: 3V(AAA * 2PCS) **RF:** 2.4GHz
Standby Power: 15µA **Control Distance:** 30m
Group Number: 4-Zone **Size(mm):** 86 * 86 * 16

RGB+CCT

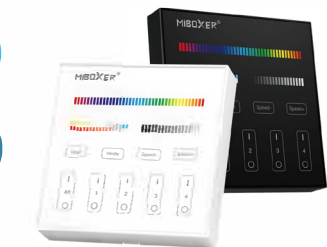

4-Zone RGB+CCT Panel Remote

Model	B4	B4-B
Color	White	Black

Working Voltage: 3V(AAA * 2PCS) **RF:** 2.4GHz
Standby Power: 15µA **Control Distance:** 30m
Group Number: 4-Zone **Size(mm):** 86 * 86 * 16



Single Color



4-Zone Single Color Panel Remote

Model	T1
Color	White

Working Voltage: AC100-240V
Standby Power: 0.15W
Group Number: 4-Zone

RF: 2.4GHz
Control Distance: 30m
Size(mm): 86 * 86 * 31

Dual White

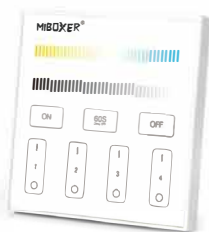

4-Zone Dual White Panel Remote

Model	T2
Color	White

Working Voltage: AC100-240V
Standby Power: 0.15W
Group Number: 4-Zone

RF: 2.4GHz
Control Distance: 30m
Size(mm): 86 * 86 * 31

RGB

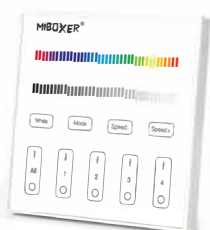

4-Zone RGB Panel Remote

Model	T3
Color	White

Working Voltage: AC100-240V
Standby Power: 0.15W
Group Number: 4-Zone

RF: 2.4GHz
Control Distance: 30m
Size(mm): 86 * 86 * 31

RGB+CCT

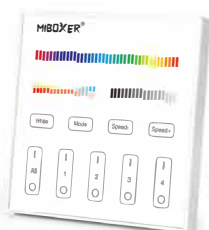

4-Zone RGB+CCT Panel Remote

Model	T4
Color	White

Working Voltage: AC100-240V
Standby Power: 0.15W
Group Number: 4-Zone

RF: 2.4GHz
Control Distance: 30m
Size(mm): 86 * 86 * 31

Dual White



Rotating Switch Panel Remote

Model	K1	K1-B
Color	White	Black

Working Voltage: 3V(CR2032)
Standby Power: <6μA
Size(mm): 86 * 86 * 27

RF: 2.4GHz
Control Distance: 30m

2.4GHz Gateway

It's wifi bridge to connect 2.4G RF products if users need to use "Miboxer" App, support 4G/5G connection and third party voice control. (Note: 5G routers do not support)

- WiFi wireless control
- 16 millions of colors to choose
- Smartphone app control
- Support third party voice control
- 2.4G RF wireless transmission technology
- Color temperature adjustable
- Can control 2.4G RF series products
- Dim brightness/Saturation

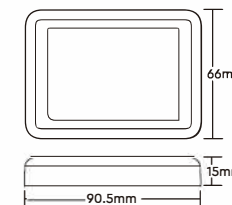

Model	Input Voltage	Transmitting Power	Working Temp.	Communication Mode	RF	Remote Control Distance
WL-Box1	DC5V/500mA (Micro USB)	6dBm	-20~60°C	WiFi-IEEE 802.11b/g/n 2.4GHz	2.4GHz	30m

2.4GHz RF Repeater

The item is 2.4G RF Repeater which support signal receiving and transmitting function. It's compatible with MiBoxer 2.4G remote series, one repeater support 12 pieces remote at the same time, the repeater is suitable for outdoor lights which install in open and long distance area.

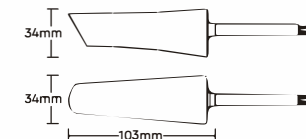

Model	Input Voltage	Transmitting Power	Standby Power Consumption	Working Temp.	IP Rate	Transmission Distance
RPI	100-240V~50/60Hz	6dBm	0.2W	-20~45°C	IP67	30m

2.4G repeater usually installed in outdoor open and long distance place, main function transmit signal while the distance is over 30m. The repeater is stable signal and cheapest cost, solved the problem for long distance control.

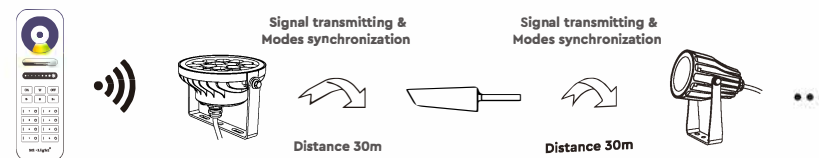

4/5-Channel High Performance Amplifier

PA4/PA5 is a newly updated high performance 4/5-channel signal amplifier. Adopt high speed optical coupler with 10Mbps output rate; it can output the signal of main controller completely and synchronously. This products work on all PWM series LED controllers in market; Made from the big current MOSFET to assure the high rate output. Everytime you add one more amplifier, you can connect twice as many as LEDs.



PA4

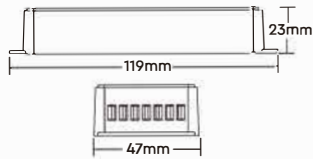

PA5

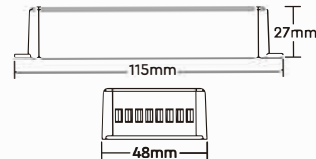

Model	Input/Output Voltage	Output Current	Total Output	Working Temp.	Switching Rate	Connection
PA4/PA5	DC12V/24V	6A/Channel	Max 15A	-20~60°C	10Mbps	Common anode

Drop voltage is big problem in LED installation, this problem always happened while the strip length is over 10m. It will affect the length of LED strip and brightness. The amplifier (PA4 & PA5) can solve drop voltage problem completely. Users can select suitable amplifier based on the feature of strip light.

Connection Diagram

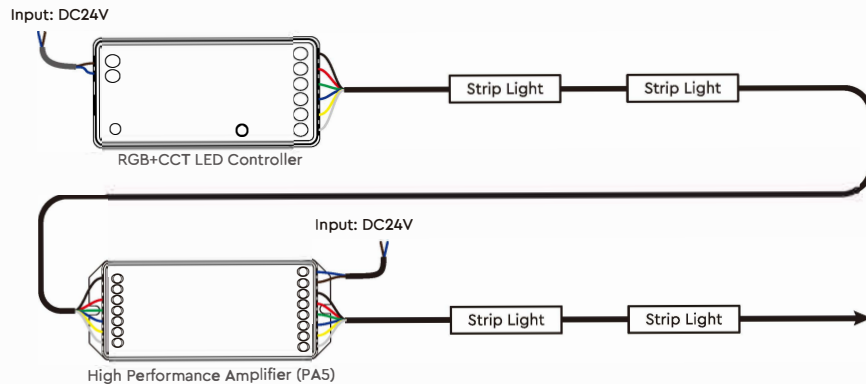

AC Triac RF+Push Dimmer

- Support PUSH dimming
- 2.4G remote control
- Trailing edge (ELV) phase-cut
- Test temperature over heat / load protection



No need to change original electric circuit and install signal cable, low cost price, convenient to construct. Dim light through remote and Link code / Unlink code simply. Small and exquisite appearance which is easy to insert into EU and USA standard wire box. It's convenient to wire and install. It has wide application for single color Triac dimmable led light, traditional filament light and halogen light.

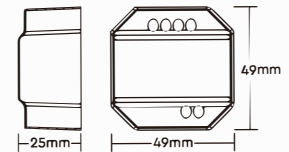

Model	Input Voltage	Output Voltage	Output Current	Output Power	Working Temp.	Dim Method	Control Distance
TRI-C1	AC100~240V 50/60Hz	AC100~240V	Max 1.36A	150W @110V 300W @220V	-10~40°C	RF wireless dimming Push dimming	30m

Connection Diagram

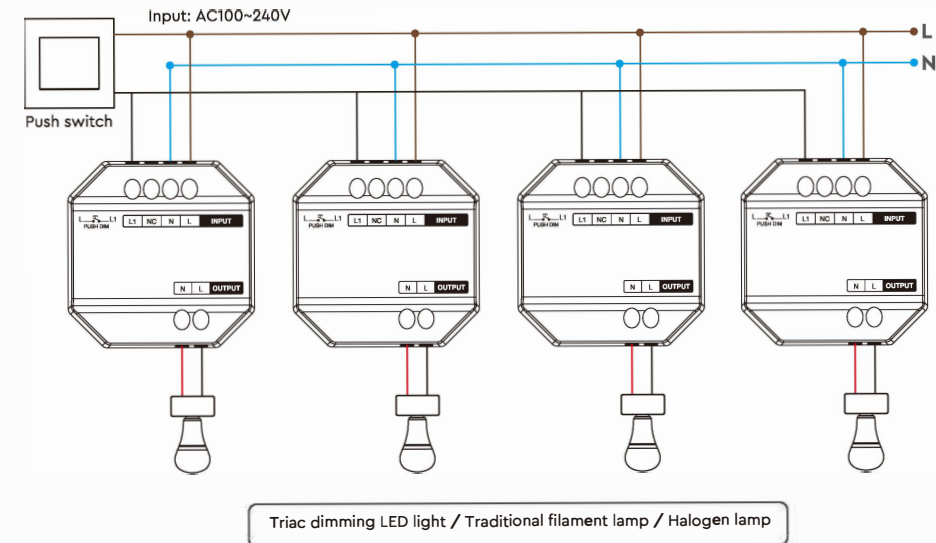



2.4G LIGHT BULB SERIES

We offer bulbs in a variety of sizes, watts, and lumens, high-performance LED beads that are long lasting and energy efficient.

Features

- 2.4G RF remote controllable.
- 16 Millions of colors to choose.
- Color temperature, Dim brightness & Saturation adjustable.
- Auto-transmitting & Synchronization function make control distance limitless.
- 50,000-hour lifespan, remarkable performance than conventional and other LED lamps.

Application

Hotels, Bars, Commercial & Residential Lighting and Exhibition Stands.

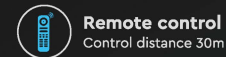

2.4G RGB+CCT LED BULBS

Including RGB+CCT and color temperature
2 kinds of bulbs and candles
Support remote control

2.4G RF



9W RGB+CCT LED Bulb

Base Type: E26 / E27 / B22
Input: 100-240V~ 50/60Hz
PF: >0.5
CRI: >80
Beam Angle: 220°
Working Temp.: -10~40°C



9W
960LM



Model	Type	Color Temp.	Power	Luminous Efficiency	RF	Control Distance
FUT012	RGB+CCT	2700K-6500K	9W	107LM/W	2.4G	30m

5W E14 RGB+CCT LED Light Bulb

Base Type: E14
Input: 100-240V~ 50/60Hz
PF: >0.5
CRI: >80
Beam Angle: 240°
Working Temp.: -10~40°C

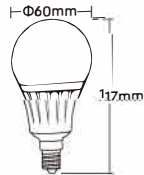

5W
450LM



Model	Type	Color Temp.	Power	Luminous Efficiency	RF	Control Distance
FUT013	RGB+CCT	2700K-6500K	5W	90LM/W	2.4G	30m

6W RGB+CCT LED Light Bulb

Base Type: E26 / E27 / B22
Input: 100-240V~ 50/60Hz
PF: >0.5
CRI: >80
Beam Angle: 220°
Working Temp.: -10~40°C

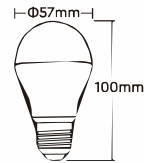

6W
550LM



Model	Type	Color Temp.	Power	Luminous Efficiency	RF	Control Distance
FUT014	RGB+CCT	2700K-6500K	6W	95LM/W	2.4G	30m



12W RGB+CCT LED Bulb

Base Type: E26 / E27
Input: 100-240V~ 50/60Hz
PF: >0.5
CRI: >80
Beam Angle: 220°
Working Temp.: -10~40°C

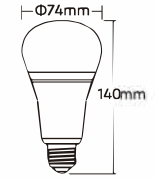

12W
1100LM



Model	Type	Color Temp.	Power	Luminous Efficiency	RF	Control Distance
FUT105	RGB+CCT	2700K-6500K	12W	90LM/W	2.4G	30m

4W GU10 RGB+CCT LED Spotlight

Base Type: GU10
Input: 100-240V~ 50/60Hz
PF: >0.55
CRI: >80
Beam Angle: 25°
Working Temp.: -10~40°C

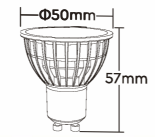

4W
320LM



Model	Type	Color Temp.	Power	Luminous Efficiency	RF	Control Distance
FUT103	RGB+CCT	2700K-6500K	4W	80LM/W	2.4G	30m

6W GU10 RGB+CCT LED Spotlight

Base Type: GU10
Input: 100-240V~ 50/60Hz
PF: >0.55
CRI: >80
Beam Angle: 30°
Working Temp.: -10~40°C

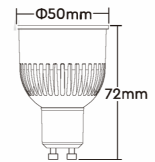

6W
550LM



Model	Type	Color Temp.	Power	Luminous Efficiency	RF	Control Distance
FUT106	RGB+CCT	2700K-6500K	6W	90LM/W	2.4G	30m

4W MR16 RGB+CCT LED Spotlight

Base Type: MR16
Input: AC / DC 12V
CRI: >80
Beam Angle: 25°
Working Temp.: -10~40°C

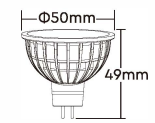

4W
400LM



Model	Type	Color Temp.	Power	Luminous Efficiency	RF	Control Distance
FUT104	RGB+CCT	2700K-6500K	4W	100LM/W	2.4G	30m



4W RGB+CCT Candle Light

Base Type: E14
 Input: 100-240V~ 50/60Hz
 PF: >0.5
 CRI: >80
 Beam Angle: 180°
 Working Temp.: -10~40°C

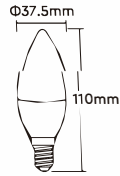

4W
320LM



Model	Type	Color Temp.	Power	Luminous Efficiency	RF	Control Distance
FUT108	RGB+CCT	2700K~6500K	4W	80LM/W	2.4G	30m

2.4G Dual White LED BULBS

Dual White bulb and candle light, adjustable color temp. and brightness, Support remote control

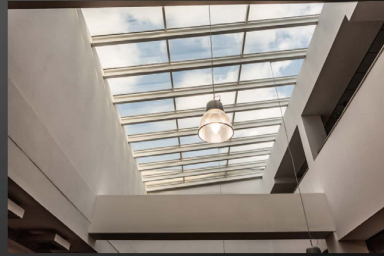

4W Dual White Candle Light

Base Type: E14
 Input: 100-240V~ 50/60Hz
 PF: >0.5
 CRI: >80
 Beam Angle: 180°
 Working Temp.: -10~40°C

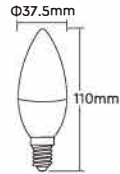

4W
400LM



Model	Type	Color Temp.	Power	Luminous Efficiency	RF	Control Distance
FUT109	CCT	2700K~6500K	4W	100LM/W	2.4G	30m



6W GU10 Dual White LED Spotlight

Base Type: GU10
 Input: 100-240V~ 50/60Hz
 PF: >0.55
 CRI: >80
 Beam Angle: 30°
 Working Temp.: -10~40°C

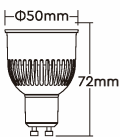

6W
580LM



Model	Type	Color Temp.	Power	Luminous Efficiency	RF	Control Distance
FUT107	CCT	2700K~6500K	6W	95LM/W	2.4G	30m



6W Dual White LED Light Bulb

Base Type: E26 / E27 / B22
 Input: 100-240V~ 50/60Hz
 PF: >0.5
 CRI: >80
 Beam Angle: 220°
 Working Temp.: -10~40°C

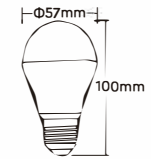

6W
500LM



Model	Type	Color Temp.	Power	Luminous Efficiency	RF	Control Distance
FUT017	CCT	2700K~6500K	6W	85LM/W	2.4G	30m



9W Dual White LED Light Bulb

Base Type: E26 / E27 / B22
 Input: 100-240V~ 50/60Hz
 PF: >0.5
 CRI: >80
 Beam Angle: 220°
 Working Temp.: -10~40°C



9W
850LM



Model	Type	Color Temp.	Power	Luminous Efficiency	RF	Control Distance
FUT019	CCT	2700K~6500K	9W	95LM/W	2.4G	30m

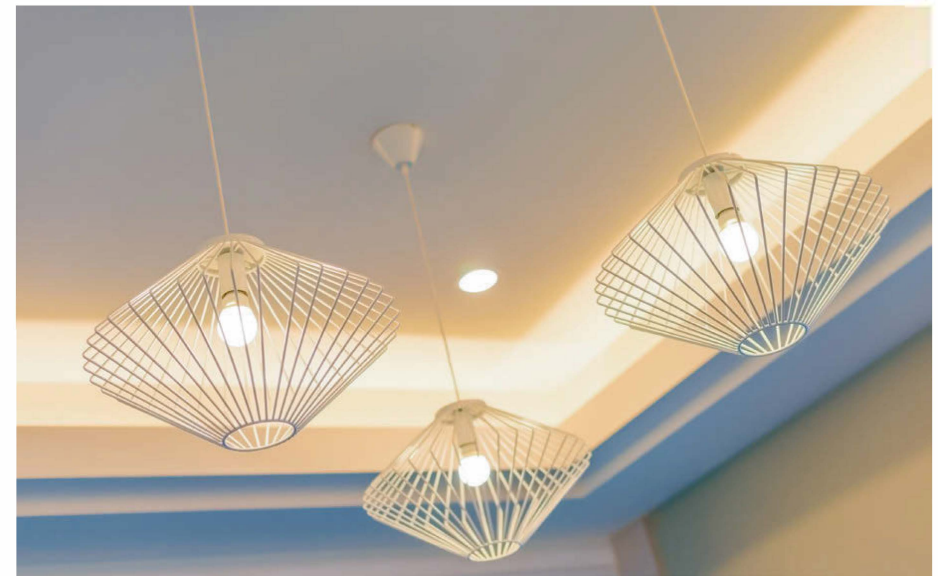



LED SPOTLIGHT SERIES

Features

- with waterproof male and female connector.
- High light transmittance mask
- Stainless steel spring buckle.
- 50,000-hour lifespan: remarkable performance than conventional and other LED lamps

Application

Wardrobe, showroom, wine cabinet.

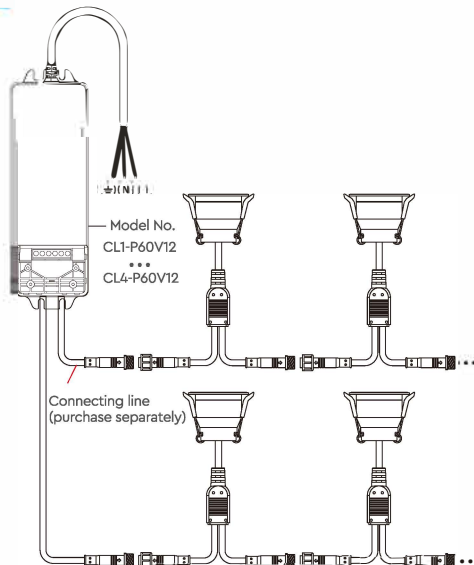

*NOTE: One LED driver supply can connect up to 20 spotlights

IP66 RATING



3W Single Color LED Spotlight

Input: 12V
 Beam Angle: 36°
 Working Temp.: -10~40°C
 Hole Size: Ø33~36mm



Model	Color Temp.	Power	Material	IP Rate
SL1-12	2000K/2200K 2400K/2700K 3000K/4000K	3W	Aluminium	IP66

IP66 RATING



3W Dual White LED Spotlight

Input: 12V
 Beam Angle: 36°
 Working Temp.: -10~40°C
 Hole Size: Ø33~36mm

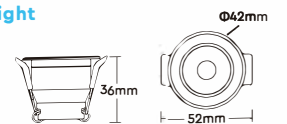

Model	Color Temp.	Power	Material	IP Rate
SL2-12	1800K~6500K 2700K~6500K	3W	Aluminium	IP66

IP66 RATING



3W RGB LED Spotlight

Input: 12V
 Beam Angle: 36°
 Working Temp.: -10~40°C
 Hole Size: Ø33~36mm

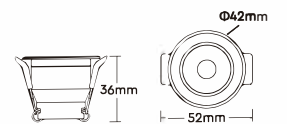

Model	Color Temp.	Power	Material	IP Rate
SL3-12		3W	Aluminium	IP66

IP66 RATING



3W RGBW LED Spotlight

Input: 12V
 Beam Angle: 36°
 Working Temp.: -10~40°C
 Hole Size: Ø33~36mm

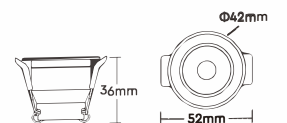

Model	Color Temp.	Power	Material	IP Rate
SL4-12	2200K/2700K	3W	Aluminium	IP66



2.4G RGB+CCT LED DOWNLIGHT SERIES

We offer LED downlight in a variety of sizes, watts, and lumens, high-performance LED beads that are long lasting and energy efficient.

Features

- 2.4G RF / Zigbee 3.0 remote controllable.
- 16 Millions of colors to choose.
- Color temperature, Dim brightness & Saturation adjustable.
- Auto-transmitting & Synchronization function make control distance limitless.
- 50,000-hour lifespan: remarkable performance than conventional and other LED lamps.

Application

Hotels, Bars, Commercial & Residential Lighting and Exhibition Stands.

LED COB DOWNLIGHT

The angle of the lamp body can be rotated
High CRI COB LED Chip

Beam Angle: 30°
Working Temp.: -10~40°C
CRI: >90
Material: Aluminium



Hole Size: Φ 70-75mm
6W



Hole Size: Φ 91-95mm
12W

2.4G RF
zigbee
NONE DIMMING
TRIAC

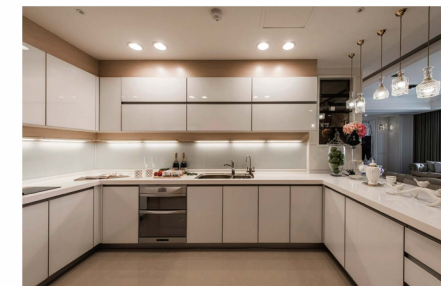

Model	Input	Color Temp.	Power	PF	Luminous Flux	Luminous Efficiency	Control Method
DW2-06A-RF	100-240V~50/60Hz	2700K~6500K	6W	>0.5	500LM	83LM/W	2.4G (Control Distance 30m)
DW2-12A-RF	100-240V~50/60Hz	2700K~6500K	12W	>0.5	1000LM	83LM/W	2.4G (Control Distance 30m)
DW2-06A-ZB	100-240V~50/60Hz	2700K~6500K	6W	>0.5	500LM	83LM/W	Zigbee 3.0 Control Distance: 100m (open area)
DW2-12A-ZB	100-240V~50/60Hz	2700K~6500K	12W	>0.5	1000LM	83LM/W	Zigbee 3.0 Control Distance: 100m (open area)
DW1-06A-TR	200-240V~50/60Hz	2700K	6W	>0.9	500LM	83LM/W	Triac Dimming
DW1-12A-TR	200-240V~50/60Hz	2700K	12W	>0.9	1050LM	87LM/W	Triac Dimming
DW1-06A-ND	100-240V~50/60Hz	2700K	6W	>0.5	500LM	83LM/W	None Dimmable
DW1-12A-ND	100-240V~50/60Hz	2700K	12W	>0.5	1050LM	87LM/W	None Dimmable

6W RGB+CCT LED Downlight



Model: FUT068 / FUT068-B
 Input: 100-240V~ 50/60Hz
 Light Efficiency: 85LM/W
 Color Temp.: 2700K~6500K
 CRI: >80
 PF: >0.5
 Beam Angle: 120°
 Working Temp.: -20~60°C
 Control Distance: 30m
 Material: Aluminium

6W
600LM

A ↑
G ↓

9W RGB+CCT LED Downlight



Model: FUT061 / FUT061-B
 Input: 100-240V~ 50/60Hz
 Light Efficiency: 80LM/W
 Color Temp.: 2700K~6500K
 CRI: >80
 PF: >0.5
 Beam Angle: 120°
 Working Temp.: -20~60°C
 Control Distance: 30m
 Material: Aluminium

9W
720LM

A ↑
G ↓

12W RGB+CCT LED Downlight

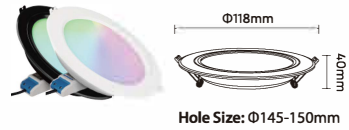

Model: FUT066 / FUT066-B
 Input: 100-240V~ 50/60Hz
 Light Efficiency: 88LM/W
 Color Temp.: 2700K~6500K
 CRI: >80
 PF: >0.5
 Beam Angle: 120°
 Working Temp.: -20~60°C
 Control Distance: 30m
 Material: Aluminium

12W
1100LM

A ↑
G ↓

18W RGB+CCT LED Downlight

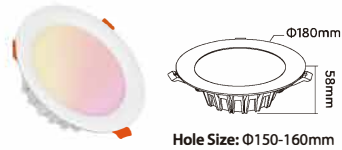

Model: FUT065
 Input: 100-240V~ 50/60Hz
 Light Efficiency: 85LM/W
 Color Temp.: 2700K~6500K
 CRI: >80
 PF: >0.5
 Beam Angle: 120°
 Working Temp.: -20~60°C
 Control Distance: 30m
 Material: Aluminium

18W
1500LM

A ↑
G ↓

25W RGB+CCT LED Downlight



Model: FUT060
 Input: 100-240V~ 50/60Hz
 Light Efficiency: 80LM/W
 Color Temp.: 2700K~6500K
 CRI: >80
 PF: >0.5
 Beam Angle: 120°
 Working Temp.: -20~60°C
 Control Distance: 30m
 Material: Aluminium

25W
2000LM

A ↑
G ↓

6W RGB+CCT Waterproof LED Downlight



Model: FUT063
 Input: 100-240V~ 50/60Hz
 Light Efficiency: 80LM/W
 Color Temp.: 2700K~6500K
 CRI: >80
 PF: >0.5
 Beam Angle: 120°
 Working Temp.: -20~60°C
 Control Distance: 30m
 Material: Aluminium

IP54
RATING

6W
500LM

A ↑
G ↓

15W RGB+CCT Waterproof LED Downlight



Model: FUT069
 Input: 100-240V~ 50/60Hz
 Light Efficiency: 80LM/W
 Color Temp.: 2700K~6500K
 CRI: >80
 PF: >0.5
 Beam Angle: 120°
 Working Temp.: -20~60°C
 Control Distance: 30m
 Material: Aluminium

IP54
RATING

15W
1200LM

A ↑
G ↓

9W RGB+CCT Square LED Downlight



Model: FUT064
 Input: 100-240V~ 50/60Hz
 Light Efficiency: 80LM/W
 Color Temp.: 2700K~6500K
 CRI: >80
 PF: >0.5
 Beam Angle: 120°
 Working Temp.: -20~60°C
 Control Distance: 30m
 Material: Aluminium

9W
720LM

A ↑
G ↓

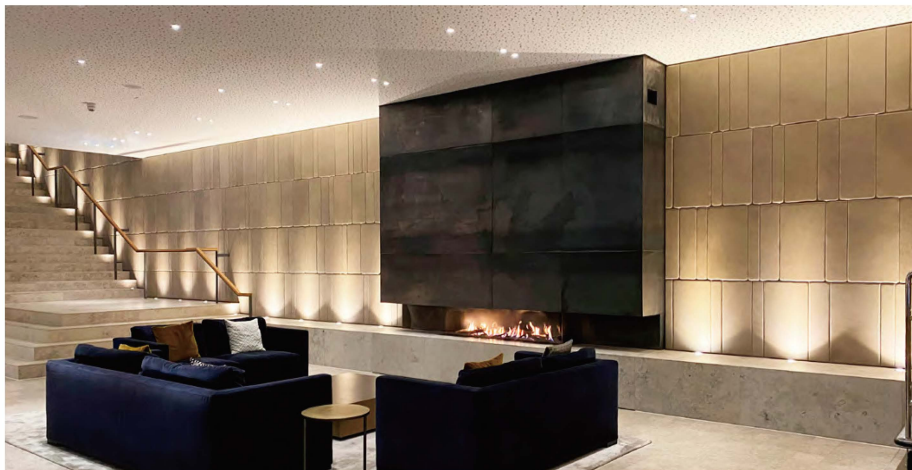

9W RGB+CCT LED Ceiling Spotlight

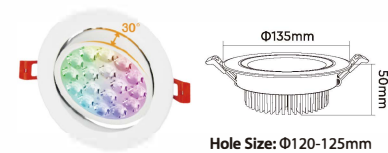

Model: FUT062
 Input: 100-240V~ 50/60Hz
 Light Efficiency: 85LM/W
 Color Temp.: 2700K~6500K
 CRI: >80
 PF: >0.5
 Beam Angle: 15°
 Working Temp.: -20~60°C
 Control Distance: 30m
 Material: Aluminium

9W
780LM

A ↑
G ↓

2.4G ANTI-GLARE RGB+CCT DOWNLIGHT



Model: FUT070
 Input: 100-240V~ 50/60Hz
 Light Efficiency: 87LM/W
 Color Temp.: 2700K~6500K
 CRI: >80
 PF: >0.5
 Beam Angle: 60°
 Working Temp.: -20~60°C
 Control Distance: 30m
 Material: Aluminium

6W
550LM

A
↑
G

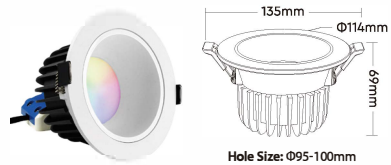

Model: FUT071
 Input: 100-240V~ 50/60Hz
 Light Efficiency: 88LM/W
 Color Temp.: 2700K~6500K
 CRI: >80
 PF: >0.5
 Beam Angle: 60°
 Working Temp.: -20~60°C
 Control Distance: 30m
 Material: Aluminium

12W
1000LM

A
↑
G



Model: FUT072
 Input: 100-240V~ 50/60Hz
 Light Efficiency: 66LM/W
 Color Temp.: 2700K~6500K
 CRI: >80
 PF: >0.5
 Beam Angle: 60°
 Working Temp.: -20~60°C
 Control Distance: 30m
 Material: Aluminium

18W
1200LM

A
↑
G



2.4G RGB+CCT LED GARDEN LIGHT SERIES

Transform the exteriors of a Building or a Garden into a Beautiful piece of Architecture. Simultaneously help navigate obstacles at night, prevent accidents and provide security.

Features

- 2.4G RF remote controllable.
- 16 Millions of colors to choose.
- Color temperature, Dim brightness & Saturation adjustable.
- Auto-transmitting & Synchronization function make control distance limitless.
- 50,000-hour lifespan: remarkable performance than conventional and other LED lamps.

Application

Public square, green belt, garden for decoration.



6W RGB+CCT LED Garden Light

Model: FUTC04
 Input: 100-240V~ 50/60Hz
 Light Efficiency: 90LM/W
 Color Temp.: 2700K~6500K
 CRI: >80
 PF: >0.5
 Beam Angle: 25°
 Working Temp.: -20~45°C
 Control Distance: 30m
 Illumination Distance: >10m

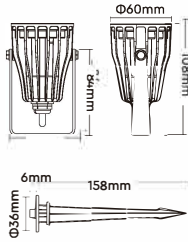

6W
550LM



18W RGB+CCT LED Garden Light

Model: FUTC09
 Input: 100-240V~ 50/60Hz
 Light Efficiency: 85LM/W
 Color Temp.: 2700K~6500K
 CRI: >80
 PF: >0.5
 Beam Angle: 25°
 Working Temp.: -20~45°C
 Control Distance: 30m
 Illumination Distance: >10m

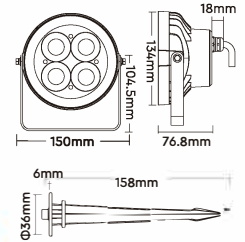

18W
1500LM



9W RGB+CCT LED Garden Light (DC24V)

Model: FUTC01
 Input: 24V~
 Light Efficiency: 100LM/W
 Color Temp.: 2700K~6500K
 CRI: >80
 Beam Angle: 15°
 Working Temp.: -20~45°C
 Control Distance: 30m
 Illumination Distance: >10m

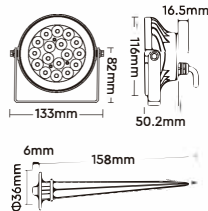

9W
900LM



25W RGB+CCT LED Garden Light

Model: FUTC05
 Input: 100-240V~ 50/60Hz
 Light Efficiency: 85LM/W
 Color Temp.: 2700K~6500K
 CRI: >80
 PF: >0.5
 Beam Angle: 15°
 Working Temp.: -20~45°C
 Control Distance: 30m
 Illumination Distance: >15m

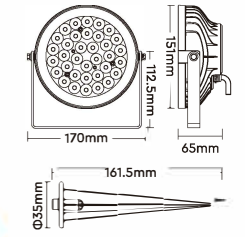

25W
2100LM



9W RGB+CCT LED Garden Light

Model: FUTC02
 Input: 100-240V~ 50/60Hz
 Light Efficiency: 100LM/W
 Color Temp.: 2700K~6500K
 CRI: >80
 PF: >0.5
 Beam Angle: 15°
 Working Temp.: -20~45°C
 Control Distance: 30m
 Illumination Distance: >10m

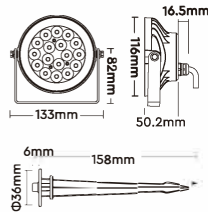

9W
900LM



50W RGB+CCT LED Garden Light

Model: FUTC06
 Input: 100-240V~ 50/60Hz
 Light Efficiency: 80LM/W
 Color Temp.: 2700K~6500K
 CRI: >80
 PF: >0.9
 Beam Angle: 25°
 Working Temp.: -20~45°C
 Control Distance: 30m
 Illumination Distance: >15m

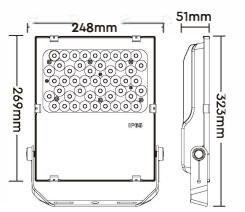

50W
4000LM



15W RGB+CCT LED Garden Light

Model: FUTC03
 Input: 100-240V~ 50/60Hz
 Light Efficiency: 100LM/W
 Color Temp.: 2700K~6500K
 CRI: >80
 PF: >0.5
 Beam Angle: 15°
 Working Temp.: -20~45°C
 Control Distance: 30m
 Illumination Distance: >10m

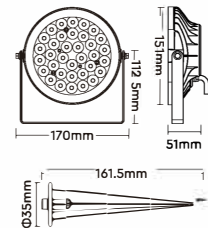

15W
1500LM



100W RGB+CCT LED Garden Light

Model: FUTC07
 Input: 100-240V~ 50/60Hz
 Light Efficiency: 75LM/W
 Color Temp.: 2700K~6500K
 CRI: >80
 PF: >0.9
 Beam Angle: 25°
 Working Temp.: -20~45°C
 Control Distance: 30m
 Illumination Distance: >15m

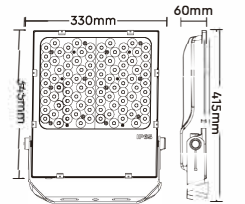

100W
7500LM





6W RGB+CCT LED Garden Light (DC24V)

Model: FUTC08
Input: 24V $\overline{\text{---}}$
Light Efficiency: 90LM/W
Color Temp.: 2700K~6500K
CRI: >80
Beam Angle: 25°
Working Temp.: -20~45°C
Control Distance: 30m
Illumination Distance: >10m



6W
550LM

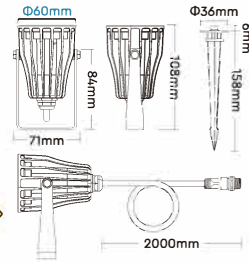

6W RGB+CCT LED Garden Light+Power Cable Kit



6W RGB+CCT LED Garden Light (DC24V)

Model: FUTC08A
Input: 24V $\overline{\text{---}}$
Light Efficiency: 90LM/W
Color Temp.: 2700K~6500K
CR: >80
Beam Angle: 25°
Working Temp.: -20~45°C
Control Distance: 30m
Illumination Distance: >10m



6W
550LM



Switching Power Supply

Input Voltage: AC100~240V 50/60Hz
Rated Input Current: 1.5A Max.
Configuration: II Conductor
Output Voltage: DC24V
Rating Load Current: 2.7A
Rating Output Power: 65W
Working Temp.: 0~45°C
Storage Temp.: -20~80°C

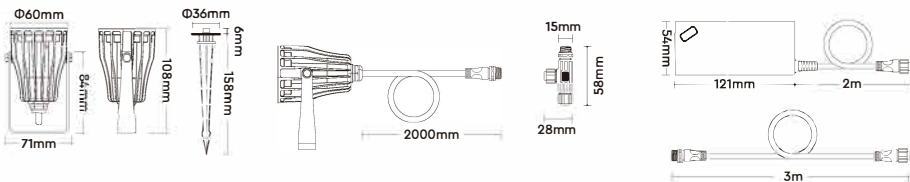

Packing list

Name	Image	Quantity
6W RGB+CCT LED garden light		3 PCS
Anti corrosion garden spike		3 PCS
Switching power supply		1 PC
Power cable		1 PC
Male to female extension cable		2 PCS
T type cable connector 2 pin		2 PCS
FUT088 Remote controller		1 PC
Manual		1 PC

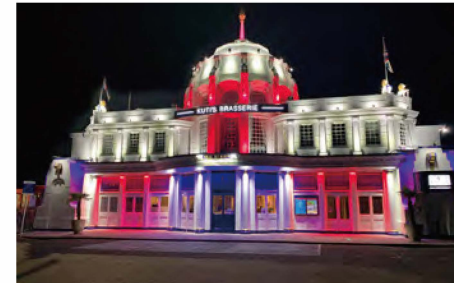
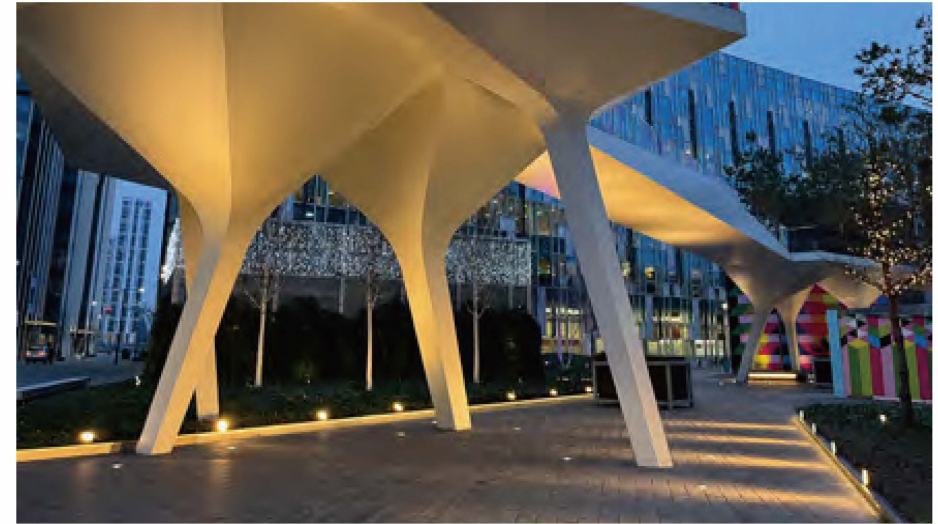

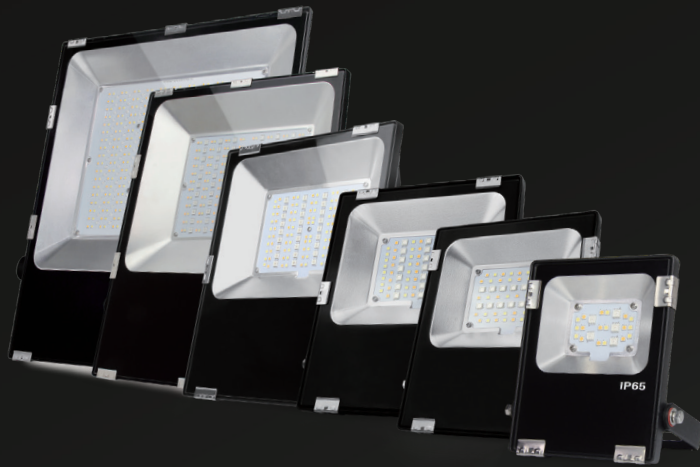

2.4G RGB+CCT LED FLOODLIGHT SERIES

Features

- 10w to 200w.
- IP65 rating -- high-quality components to ensure waterproof/airtight performance.
- 16 Millions of colors to choose.
- Color temperature, Dim brightness & Saturation adjustable.
- Auto-transmitting & Synchronization function make control distance limitless.
- 50,000-hour lifespan: remarkable performance than conventional and other LED lamps.

Application

Mainly used for lighting in ports, docks, tunnels, stadiums, building decoration, outdoor, billboards and other places.



2.4G RGB+CCT LED Floodlight

Revolutionary high-powered LED floodlight with smart RGB+CCT technology. Multi colour options and adjustable white temperature will create different lighting experiences to best suit the environment and occasion.



10W RGB+CCT LED Floodlight

Model: FUTT05
Input: 100-240V~ 50/60Hz
Light Efficiency: 100LM/W
Color Temp.: 2700K-6500K
CRI: >80
PF: >0.5
Beam Angle: 160°
Working Temp.: -20~45°C
Control Distance: 30m
Illumination Distance: >8m

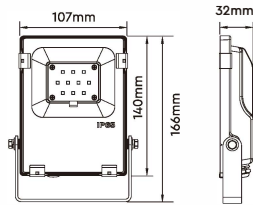

10W RGB+CCT LED Floodlight (DC24V)

Model: FUTT06
Input: 24V
Light Efficiency: 115LM/W
Color Temp.: 2700K-6500K
CRI: >80
Beam Angle: 160°
Working Temp.: -20~45°C
Control Distance: 30m
Illumination Distance: >8m

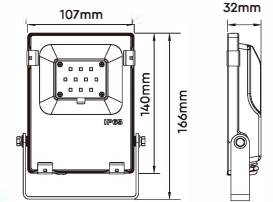

20W RGB+CCT LED Floodlight

Model: FUTT04
Input: 100-240V~ 50/60Hz
Light Efficiency: 115LM/W
Color Temp.: 2700K-6500K
CRI: >80
PF: >0.5
Beam Angle: 160°
Working Temp.: -20~45°C
Control Distance: 30m
Illumination Distance: >12m

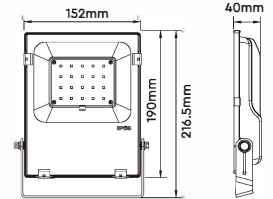

30W RGB+CCT LED Floodlight

Model: FUTT03
Input: 100-240V~ 50/60Hz
Light Efficiency: 110LM/W
Color Temp.: 2700K-6500K
CRI: >80
PF: >0.9
Beam Angle: 160°
Working Temp.: -20~45°C
Control Distance: 30m
Illumination Distance: >18m

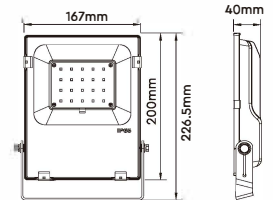



50W RGB+CCT LED Floodlight

Model: FUTT02
 Input: 100-240V~ 50/60Hz
 Light Efficiency: 96LM/W
 Color Temp.: 2700K-6500K
 CRI: >80
 PF: >0.9
 Beam Angle: 160°
 Working Temp.: -20~45°C
 Control Distance: 30m
 Illumination Distance: >25m



50W
4800LM

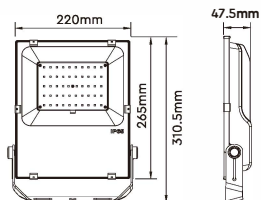

100W RGB+CCT LED Floodlight

Model: FUTT07
 Input: 100-240V~ 50/60Hz
 Light Efficiency: 100LM/W
 Color Temp.: 2700K-6500K
 CRI: >80
 PF: >0.9
 Beam Angle: 160°
 Working Temp.: -20~45°C
 Control Distance: 30m
 Illumination Distance: >35m



100W
10000LM

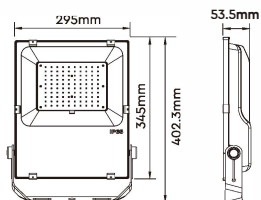

200W RGB+CCT LED Floodlight

Model: FUTT08
 Input: 100-240V~ 50/60Hz
 Light Efficiency: 90LM/W
 Color Temp.: 2700K-6500K
 CRI: >80
 PF: >0.95
 Beam Angle: 160°
 Working Temp.: -20~45°C
 Control Distance: 30m
 Illumination Distance: >50m



200W
18400LM

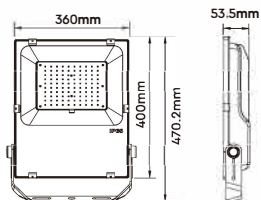

2.4G RGB+CCT LED Wall Washer Light

The wall washer adopts high-quality LED lamp beads and excellent beam control to ensure uniform brightness, ideal for architectural specification and projects requiring facade lighting which will create a dynamic linear illumination and fit seamlessly into a building's structure.

Color Temp.: 2700K-6500K
 Lifespan: 50,000h
 Working Temp.: -20~45°

CRI: >80
 RF: 2.4GHz
 Control Distance: 30m



Remote control
Control distance 30m

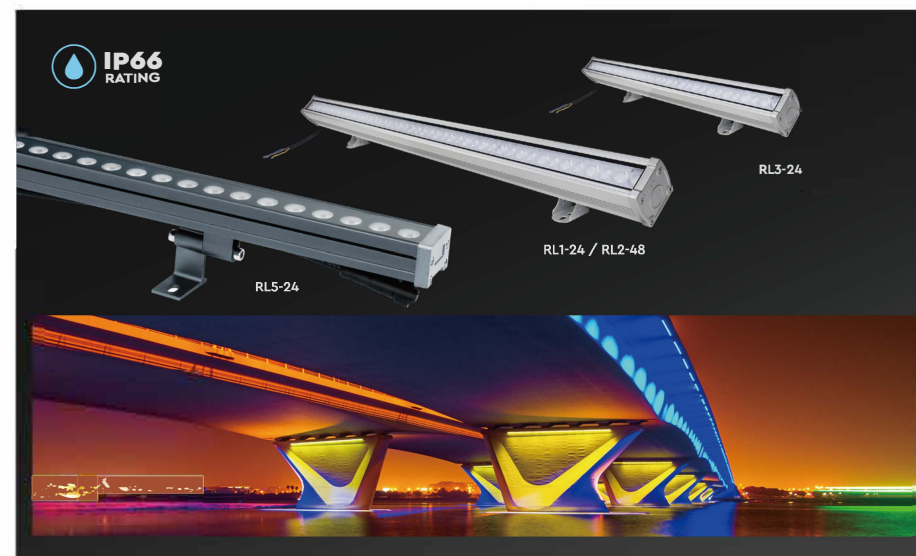

Model	Input	Power	PF	Luminous Flux	Luminous Efficiency	Beam Angle	Size
RL1-24	100-240V~ 50/60Hz	24W	>0.9	1800LM	75LM/W	15°60°	1017*62*64mm
RL2-48	100-240V~ 50/60Hz	48W	>0.9	3200LM	65LM/W	15°60°	1017*62*64mm
RL3-24	100-240V~ 50/60Hz	24W	>0.9	1600LM	66LM/W	15°60°	521*62*64mm
RL5-24	24V---	24W	---	1600LM	70LM/W	24°	994*34*25mm

Features

DMX512 is a standard for digital communication networks that are commonly used to control lighting and effects. It was originally intended as a standardized method for controlling stage lighting dimmers, which, prior to DMX512, had employed various incompatible proprietary protocols. It quickly became the primary method for linking controllers (such as a lighting console) to dimmers and special effects devices such as fog machines and intelligent lights.

Application

Commercial lighting, Bars, Hotel, Official lighting, Restaurant, Architectural lighting.



DMX512 SERIES





72W RGBW LED Wall Washer Light (DMX512 & RDM)

Model: D4-W72
Input: 100-240V~ 50/60Hz
Power: 72W
Luminous Flux: R:560LM G:1080LM B:300LM W:2600LM
Color Temp.: 2700K~3000K
CRi: >80
PF: >0.9
Beam Angle: 15°60°
Working Temp.: -20~45°C
Input Signal: DMX512, RDM
Occupy 4 DMX Address

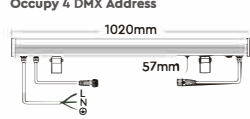

DMX512 Master(Single Color)

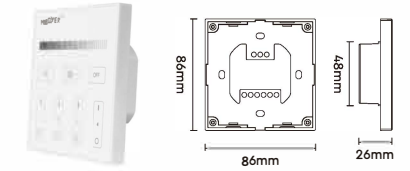

Model No.: X1
Input Voltage: 100-240V~ 50/60Hz
Output: DMX512 + 2.4G Wireless
RF Transmitting Power: 6dBm
Working Temp.: -20~45°C



72W RGB+CCT LED Wall Washer Light (DMX512 & RDM)

Model: D5-W72
Input: 100-240V~ 50/60Hz
Power: 72W
Luminous Flux: R:280LM G:540LM B:150LM CW:1800LM WW:1650LM
Color Temp.: 2700K~6500K
CRi: >80
PF: >0.9
Beam Angle: 15°60°
Working Temp.: -20~45°C
Input Signal: DMX512, RDM
Occupy 5 DMX Address

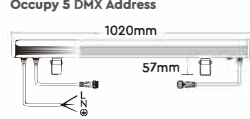

DMX512 Master(Color Temperature)

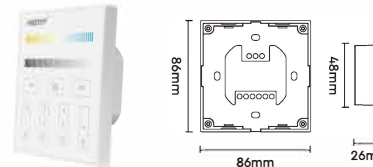

Model No.: X2
Input Voltage: 100-240V~ 50/60Hz
Output: DMX512 + 2.4G Wireless
RF Transmitting Power: 6dBm
Working Temp.: -20~45°C

DMX512 Master(RGB)

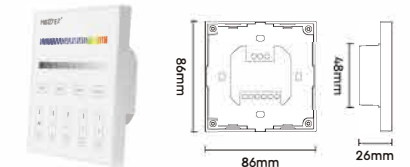

Model No.: X3
Input Voltage: AC100~240V 50/60Hz
Output: DMX512 + 2.4G Wireless
RF Transmitting Power: 6dBm
Working Temp.: -20~45°C



50W RGB+CCT LED Garden Light

Model: D5-G50
Input: 100-240V~ 50/60Hz
Luminous Efficiency: 80LM/W
Color Temp.: 2700K~6500K
CRi: >80
PF: >0.9
Beam Angle: 25°
Working Temp.: -20~45°C
Input Signal: DMX512, RDM
Illumination distance: >15m
Occupy 5 DMX Address

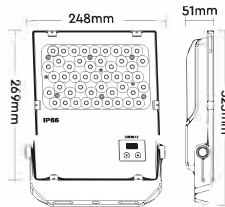

50W
4000LM



100W RGB+CCT LED Garden Light

Model: D5-G100
Input: 100-240V~ 50/60Hz
Luminous Efficiency: 75LM/W
Color Temp.: 2700K~6500K
CRi: >80
PF: >0.9
Beam Angle: 25°
Working Temp.: -20~45°C
Input Signal: DMX512, RDM
Illumination distance: >15m
Occupy 5 DMX Address

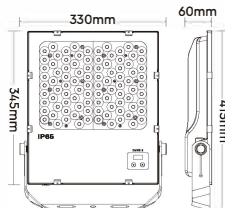

100W
7500LM



DMX512 Master(RGBW)

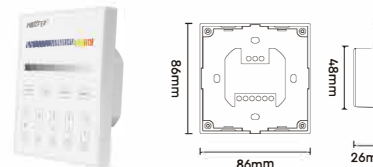

Model No.: X4
Input Voltage: AC100~240V 50/60Hz
Output: DMX512 + 2.4G Wireless
RF Transmitting Power: 6dBm
Working Temp.: -20~45°C

DMX512 Master(RGB+CCT)

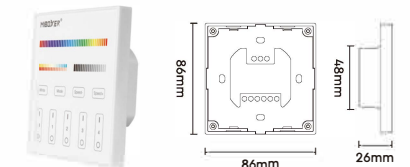

Model No.: X5
Input Voltage: AC100~240V 50/60Hz
Output: DMX512 + 2.4G Wireless
RF Transmitting Power: 6dBm
Working Temp.: -20~45°C

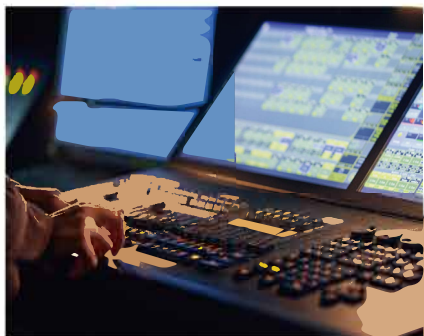

1-Channel Constant Voltage DMX512 & RDM Decoder

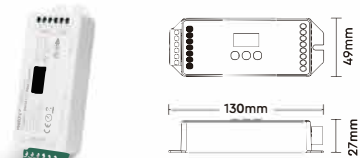

Model No.: D1-CX
 Input Voltage: 12V~24V $\overline{\text{---}}$
 Output Current: 20A/Channel
 Total Output Current: Max 20A
 Input Signal: DMX512, RDM
 Working Temp.: -20~45°C

2-Channel Constant Voltage DMX512 & RDM Decoder

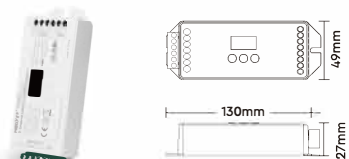

Model No.: D2-CX
 Input Voltage: 12V~24V $\overline{\text{---}}$
 Output Current: 10A/Channel
 Total Output Current: Max 20A
 Input Signal: DMX512, RDM
 Working Temp.: -20~45°C

3-Channel Constant Voltage DMX512 & RDM Decoder

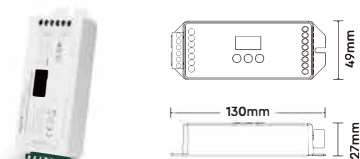

Model No.: D3-CX
 Input Voltage: 12V~24V $\overline{\text{---}}$
 Output Current: 6A/Channel
 Total Output Current: Max 18A
 Input Signal: DMX512, RDM
 Working Temp.: -20~45°C

4-Channel Constant Voltage DMX512 & RDM Decoder

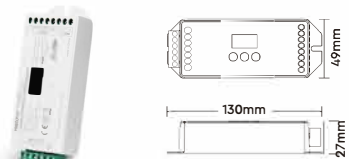

Model No.: D4-CX
 Input Voltage: 12V~24V $\overline{\text{---}}$
 Output Current: 5A/Channel
 Total Output Current: Max 20A
 Input Signal: DMX512, RDM
 Working Temp.: -20~45°C

5-Channel Constant Voltage DMX512 & RDM Decoder

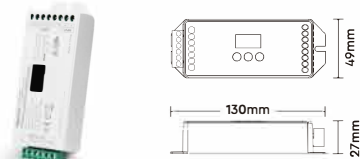

Model No.: D5-CX
 Input Voltage: 12V~24V $\overline{\text{---}}$
 Output Current: 4A/Channel
 Total Output Current: Max 20A
 Input Signal: DMX512, RDM
 Working Temp.: -20~45°C



DMX 512 LED Transmitter

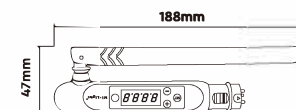

Model	Input	RF Transmitting Power	RF	Input Signal	Control Distance
FUTD01	DC5V / 500mA	6dBm	2.4G	DMX512	30m

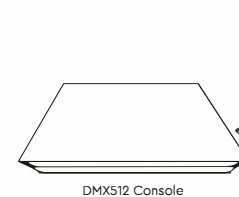

Connect

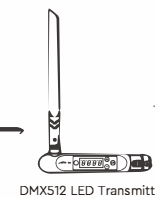

2.4GHz RF
Transmission Tech
» » » » »

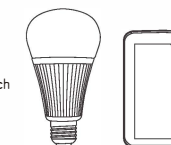

For more supported LED lights or controllers, please refer to the relevant manuals



DALI SERIES

DALI Bus Power Supply (DIN Rail)

DL-POW1 is a newly developed DALI BUS power supply, up to class 2 power supply standard and SELV safety extra-low voltage standard; It's with short-circuit protection and low-voltage protection; The case is with anti-fire material. Isolation Resistance: I/P-O/P:100MΩ/500VDC/25°C/70%RH.



Model: DL-POW1
Input Voltage: AC100~240V 50/60Hz
Input Current: 115Vac/≤0.09A, 230Vac/≤0.05A
Leakage Current: <0.5mA/230Vac
Inrush Current: Cold start 10A at 230Vac
Output Voltage: DC16V
Output Current: 250mA Max
Max. Rated Power: 4W
Setup Time: 115Vac<2500ms, 230Vac<1500ms (at full load)
Ripple & Noise: 0.2Vp-p (at full load)
Working Temp.: -20~60°C
Working Humidity: 20~95%RH, non-condensing

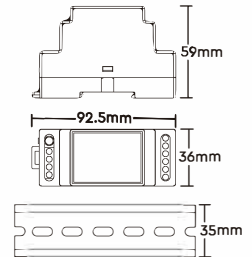

DIN-Rail mounting size: TS-35/7.5 or TS-35/15 (Purchasing separately)

DALI 5 in 1 LED Controller (DT8)

The constant voltage LED strip controller adopts DALI standard protocol and supports DT8 type. PWM pulse dimming output, smooth brightness dimming, and strong compatibility. Five output modes, including brightness, color temperature, RGB, RGBW, RGB+CCT. Widely used in hotel lighting and home lighting control.



- 16 millions of colors to choose
- Color temperature adjustable
- Dim brightness / Saturation

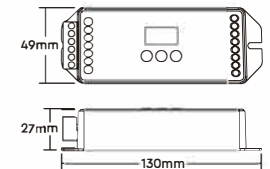

Model	Input Voltage	Input Signal	DALI Bus Standard	Output	Total Output Max	Working Temp.
DL-X	DC12~24V	DALI Signal or Push Dimming	IEC62386	6A/Channel	20A	-10~40°C

Support DT8 type Tc / xy coordinates / RGBWAF

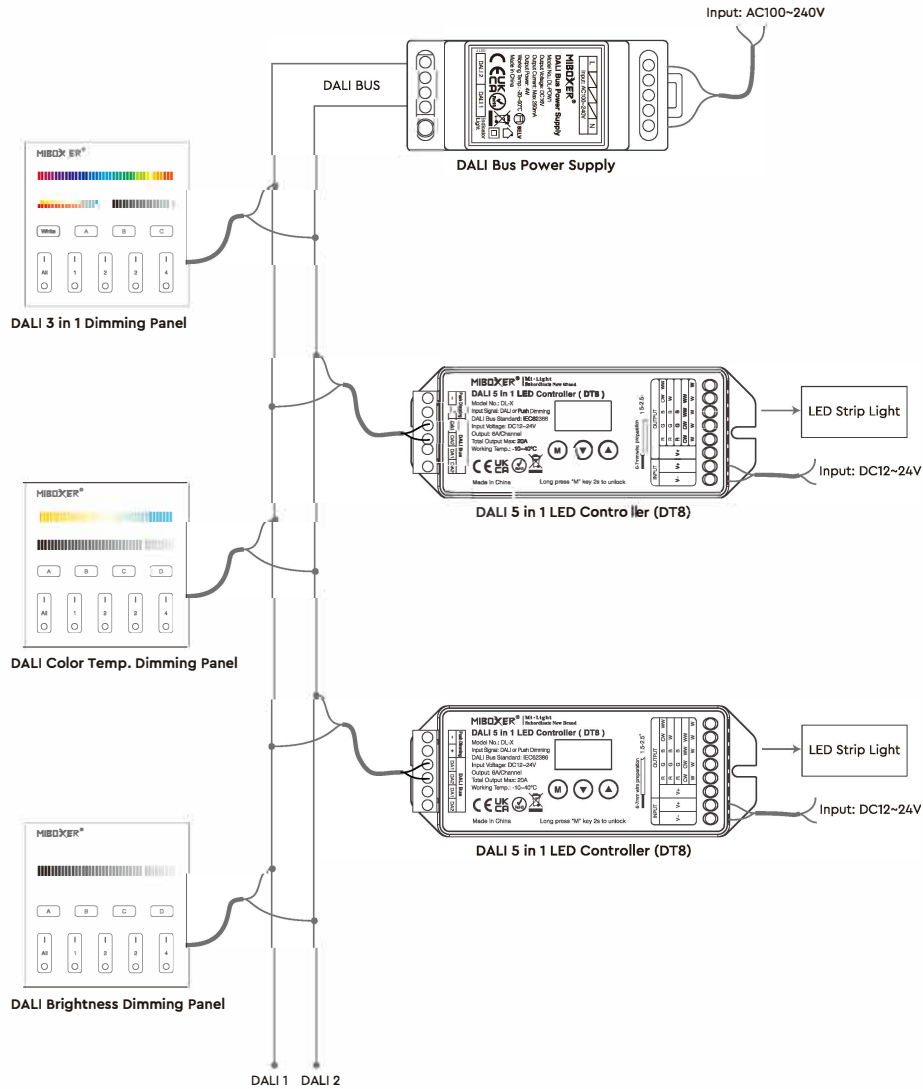

DALI Touch Panel

This panel controller is designed by a delicate and fashionable tempered glass panel; And we adopt a high precision capacitive touch screen IC. Touch screen is very stable. Use DALI standard protocol IEC62386. Support single address mode, group address mode and broadcast mode.

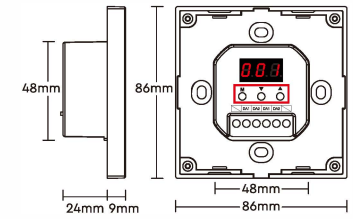

- DALI Standard Protocol IEC62386
- Sensitive Touching
- LED Night Indicator
- Scratch Resistance
- The address can be set by pressing the key

Model	Power Supply	DALI Bus Standard	Output Signal	Controlling Type	Standby Current	Working Temp.	Weight
DP1S				Dimming (DT6)			
DP2S	DALI Power	IEC62386	DALI Signal	CCT (DT8 type: Tc)	<4mA@16V	-10~40°C	145g
DP3S				RGB(DT8 type: xy coordinates) RGBW(DT8 type: RGBWAF) RGB+CCT(DT8 type: RGBWAF)			





SYS SERIES

1-Channel Host Controller

The following controller adopt the widely used 2.4GHz wireless technology with the features of low power consumption, long signal transmitting and strong anti-interference, etc. Only compatible with SYS series products, including wall washer light, underwater light and Garden Light, etc.



- 16 Millions colors
- 2.4GHz remote control
- App control (need 2.4GHz Gateway WL-Box1)
- Saturation adjustable
- Color temp. adjustable
- Dim brightness
- Third party voice control (need 2.4GHz Gateway WL-Box1)
- DMX512 control (need transmitter FUTD01)

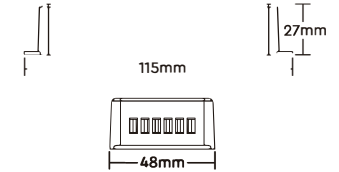

Model	Input Voltage	Output Voltage	Output Current	Output Power	Working Temp.	Control Method	Control Distance
SYS-T1	DC24V	DC24V	Max 15A	Max 360W	-20~60°C	2.4G	30m

1-Channel Signal Power Amplifier

The amplifier is to amplify the power and signal for "SYS-T1 1-Channel Host Controller". It can amplify the signal from "SYS-T1 Controller" to connect more LED lamps, and synchronously control more lamps. When you add one more amplifier, you can connect double LED lamps.

Note: When using "SYS-T1 controller", you need to add "SYS-T2 1-channel signal amplifier" for below 3 situations.

- Connecting over 50pcs lights
- Connected cable length over 300m
- Output power over 360W

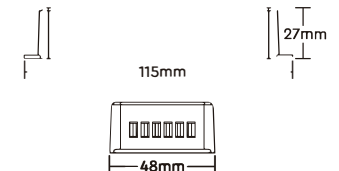

Model	Input Voltage	Output Voltage	Output Current	Output Power	Working Temp.
SYS-T2	DC24V	DC24V	Max 15A	Max 360W	-20~60°C

SYS SUBORDINATE LAMP

Connection Diagram

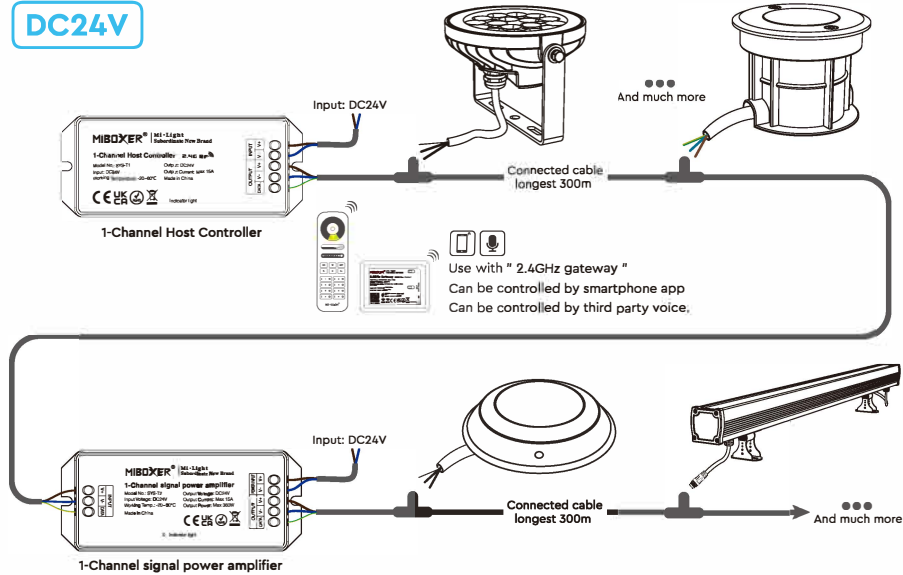

This product has to be connected to "SYS-T1 Controller" to fulfill the remote controlling

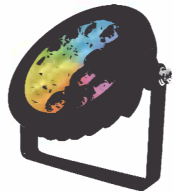

9W RGB+CCT LED Garden Light

Model: SYS-RC1
 Input: DC24V
 Luminous Efficiency: 100LM/W
 Color Temp.: 2700K~6500K
 CRI: >80
 Beam Angle: 15°
 Working Temp.: -20~45°C
 Illumination distance: >10m
 Lifespan: 50000h

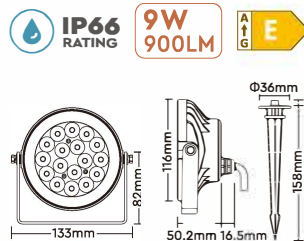

15W RGB+CCT LED Garden Light

Model: SYS-RC2
 Input: DC24V
 Luminous Efficiency: 100LM/W
 Color Temp.: 2700K~6500K
 CRI: >80
 Beam Angle: 15°
 Working Temp.: -20~45°C
 Illumination distance: >10m
 Lifespan: 50000h

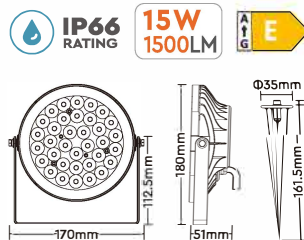

5W RGB+CCT LED Underground Light

Model: SYS-RD1
 Input: DC24V
 Luminous Efficiency: 80LM/W
 Color Temp.: 2700K~6500K
 CRI: >80
 Beam Angle: 30°
 Working Temp.: -20~60°C
 Lifespan: 50000h

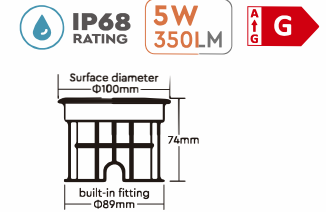

9W RGB+CCT LED Underground Light

Model: SYS-RD2
 Input: DC24V
 Luminous Efficiency: 80LM/W
 Color Temp.: 2700K~6500K
 CRI: >80
 Beam Angle: 15°
 Working Temp.: -20~60°C
 Lifespan: 50000h

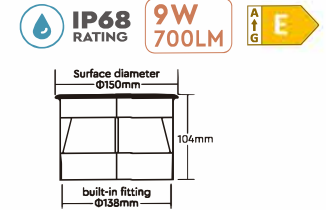

15W RGB+CCT Underwater Light

Model: SYS-RW1
 Input: DC24V
 Luminous Efficiency: 72LM/W
 Color Temp.: 2700K~6500K
 CRI: >80
 Beam Angle: 160°
 Working Temp.: -20~45°C
 Lifespan: 50000h



24W RGB+CCT Wall Washer Light

Model: SYS-RL1
 Input: DC24V
 Luminous Efficiency: 75LM/W
 Color Temp.: 2700K~6500K
 CRI: >80
 Beam Angle: 15°60°
 Working Temp.: -20~60°C
 Illumination Distance: >15m
 Lifespan: 50000h

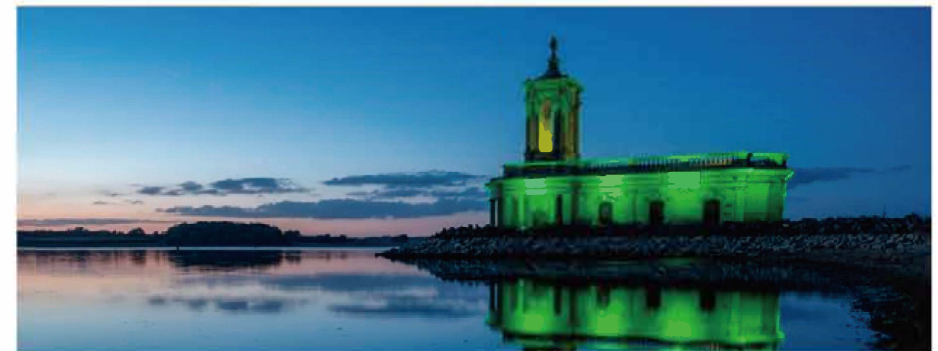
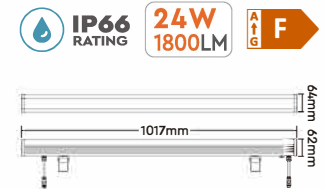

Features

LoRa Radio Module 433MHz is a low power long range wireless network module, which can realize wide area communication. Most of them are used in underwater light or in open area, max control distance is over 2km. Mixerbox under water light can use remote or APP control the light under water around 0.5m, 50,000-hour lifespan.

Application

Pool project, Agricultural lighting, Fountain lighting, Garden lighting.



433MHZ LORA SERIES

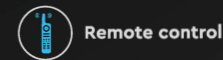



24W RGB+CCT LED Wall Washer Light

Model: RL1-24L
 Input: 100-240V~ 50/60Hz
 Luminous Efficiency: 75LM/W
 Color Temp.: 2700K~6500K
 CRI: >80
 PF: >0.9
 Beam Angle: 15°60°
 Working Temp.: -20~45°C
 Control Distance: 2000m
 Illumination Distance: >15m



24W
1800LM

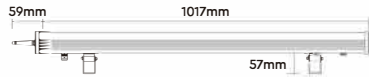
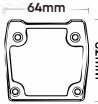

48W RGB+CCT LED Wall Washer Light

Model: RL2-48L
 Input: 100-240V~ 50/60Hz
 Luminous Efficiency: 66LM/W
 Color Temp.: 2700K~6500K
 CRI: >80
 PF: >0.9
 Beam Angle: 15°60°
 Working Temp.: -20~45°C
 Control Distance: 2000m
 Illumination Distance: >20m



48W
3200LM

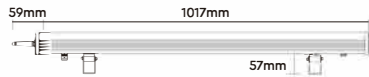
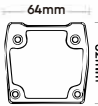

15W RGB+CCT Wall-mounted Underwater Light

Model: UW01
 Input: 12V~ / 12V-24V ~~~
 Luminous Efficiency: 72LM/W
 Color Temp.: 2700K~6500K
 CRI: >80
 Beam Angle: 160°
 Working Temp.: -20~45°C
 Control distance: 50m (Lamps into 0.5m underwater)



15W
1100LM

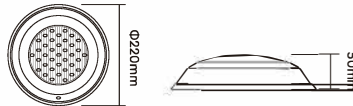

27W RGB+CCT Wall-mounted Underwater Light

Model: UW02
 Input: 12V~ / 12V-24V ~~~
 Luminous Efficiency: 75LM/W
 Color Temp.: 2700K~6500K
 CRI: >80
 Beam Angle: 160°
 Working Temp.: -20~45°C
 Control distance: 50m (Lamps into 0.5m underwater)



27W
2000LM

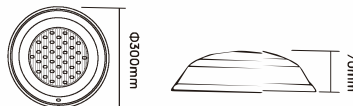

9W RGB+CCT LED Underwater Light

Model: UW03
 Input: 12V~ / 12V-24V ~~~
 Luminous Efficiency: 70LM/W
 Color Temp.: 2700K~6500K
 CRI: >80
 Beam Angle: 15°
 Working Temp.: -20~45°C
 Control distance: 50m (Lamps into 0.5m underwater)



9W
600LM

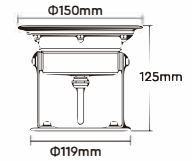

27W RGB+CCT PAR56 LED Pool Light

Model: PW01
 Input: 12V~ / 12V-24V ~~~
 Luminous Efficiency: 95LM/W
 Color Temp.: 2700K~6500K
 CRI: >80
 Beam Angle: 160°
 Working Temp.: -20~45°C
 Control distance: 50m (Lamps into 0.5m underwater)



27W
2600LM

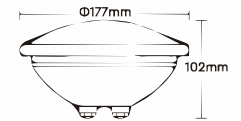

18W RGB+CCT PAR56 LED Pool Light

Model: PW02
 Input: 12V~ / 12V-24V ~~~
 Luminous Efficiency: 100LM/W
 Color Temp.: 2700K~6500K
 CRI: >80
 Beam Angle: 160°
 Working Temp.: -20~45°C
 Control distance: 50m (Lamps into 0.5m underwater)



18W
1800LM

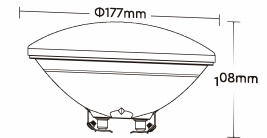

9W RGB+CCT LED Underground Light

Model: RD-9L
 Input: 12V~ / 12V-24V ~~~
 Luminous Efficiency: 70LM/W
 Color Temp.: 2700K~6500K
 CRI: >80
 Beam Angle: 15°
 Working Temp.: -20~45°C



9W
600LM

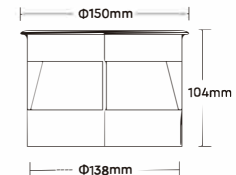



25W RGB+CCT LED Garden Light

Model: FUTC05L
Input: 100-240V~ 50/60Hz
Luminous Efficiency: 85LM/W
Color Temp.: 2700K~6500K
CRi: >75
PF: >0.5
Beam Angle: 15°
Working Temp.: -20~45°C
Control distance: 2000m
Illumination distance: >15m

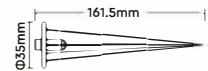
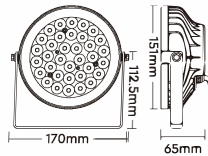

50W RGB+CCT LED Garden Light

Model: FUTC06L
Input: 100-240V~ 50/60Hz
Luminous Efficiency: 80LM/W
Color Temp.: 2700K~6500K
CRi: >80
PF: >0.9
Beam Angle: 25°
Working Temp.: -20~45°C
Control distance: 2000m
Illumination distance: >15m

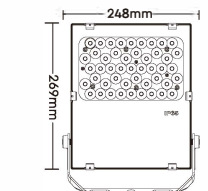

LoRa RGB+CCT LED Controller

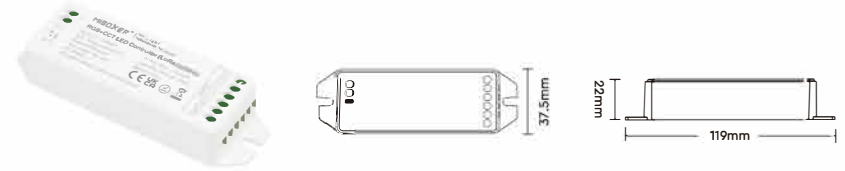

Model	Input	Output	Total Output	Modulation Method	Control Distance
FUT039L	12V~24V	6A/Channel	Max 12A	LoRa spread spectrum	500m

LoRa 8-Zone 433MHz Remote Controller



Model	Working Voltage	Power	Modulation Method	Control Distance
FUT086	3V (AAA * 2PCS)	RF Transmitting Power: 10dBm Standby Power Consumption: 16μA	LoRa spread spectrum	50m (Lamps into 0.5m underwater) 1000m (Lamps on the open area)

LoRa 433MHz Gateway Smartphone app control | Support third party voice control

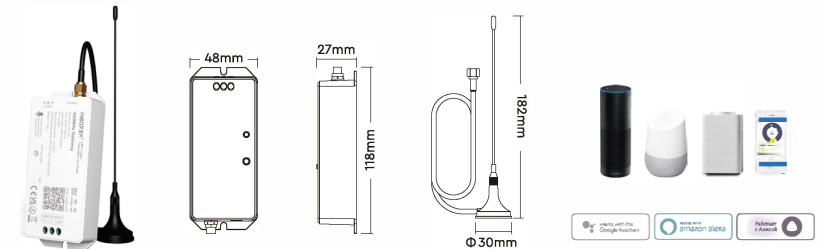

Model	Input	InputSignal	Communication Mode	Modulation Method	Control Distance
WL-433	DC5V/500mA	DMX512 (1990)	WiFi-IEEE 802.11b/g/n 2.4GHz	LoRa spread spectrum	50m (Lamps into 0.5m underwater) 1000m (Lamps on the open area)