

# BASIC DESCRIPTION

## Easy stair lighting controller

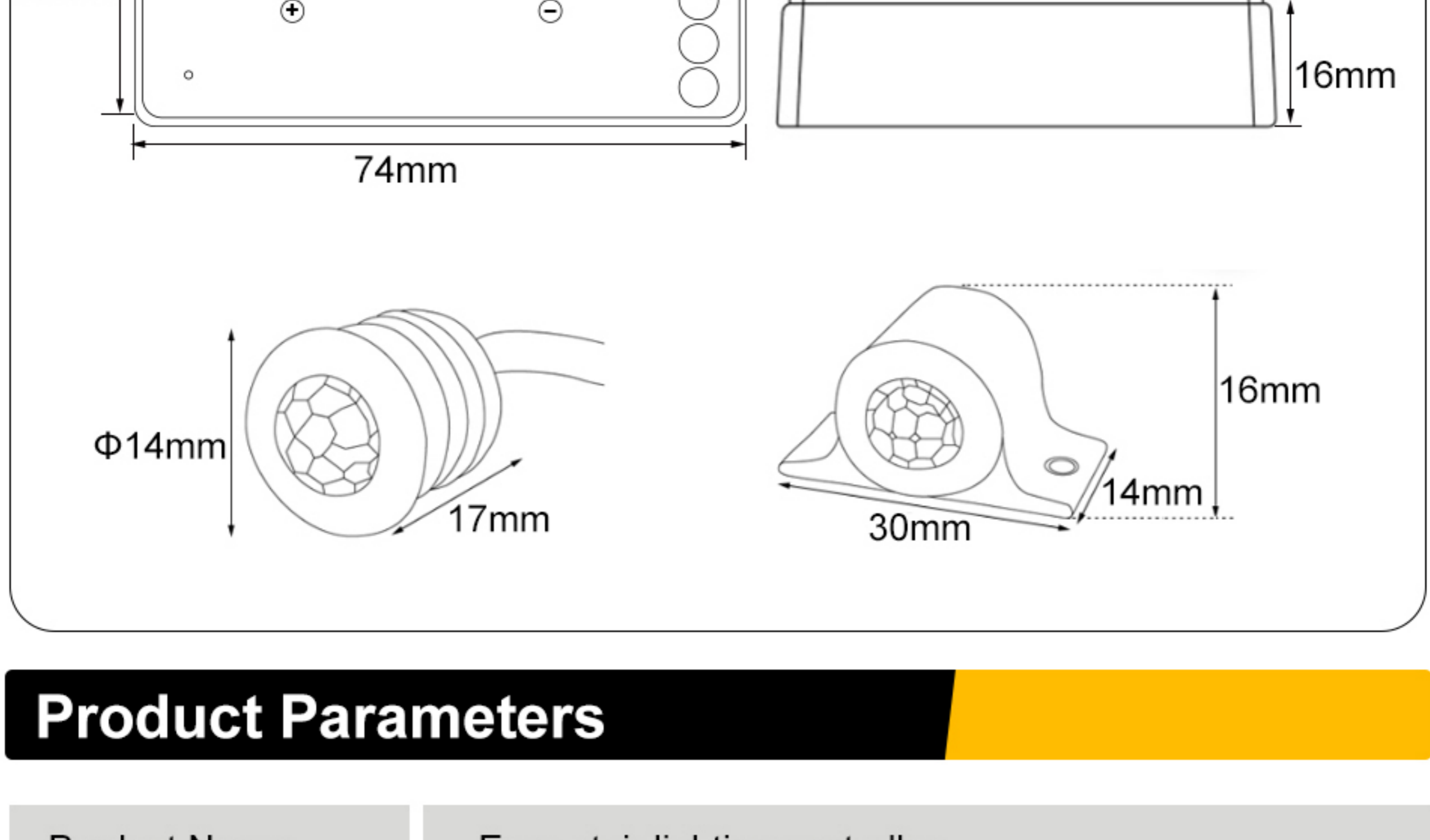

## Stair Controller Dimension



## Product Parameters

Product Name	Easy stair lighting controller
Model Number	RL-S01
Input Voltage	DC12V-DC24V
Max Current	8A
Power	DC12V/96W Max, DC24V/192W Max
Material	PC
Color	White

## Installation Diagram

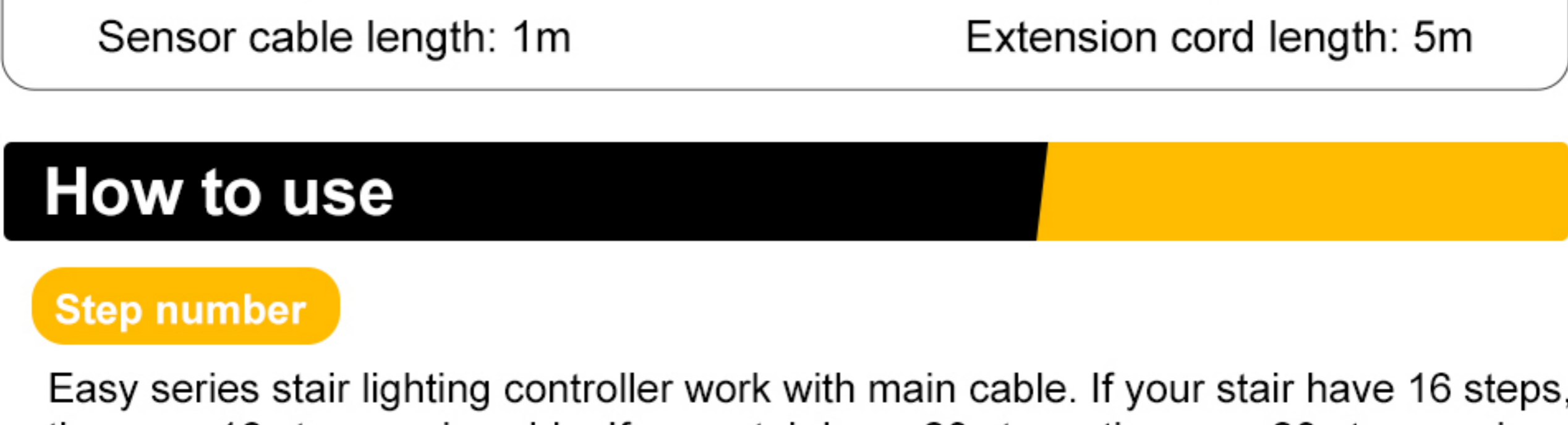
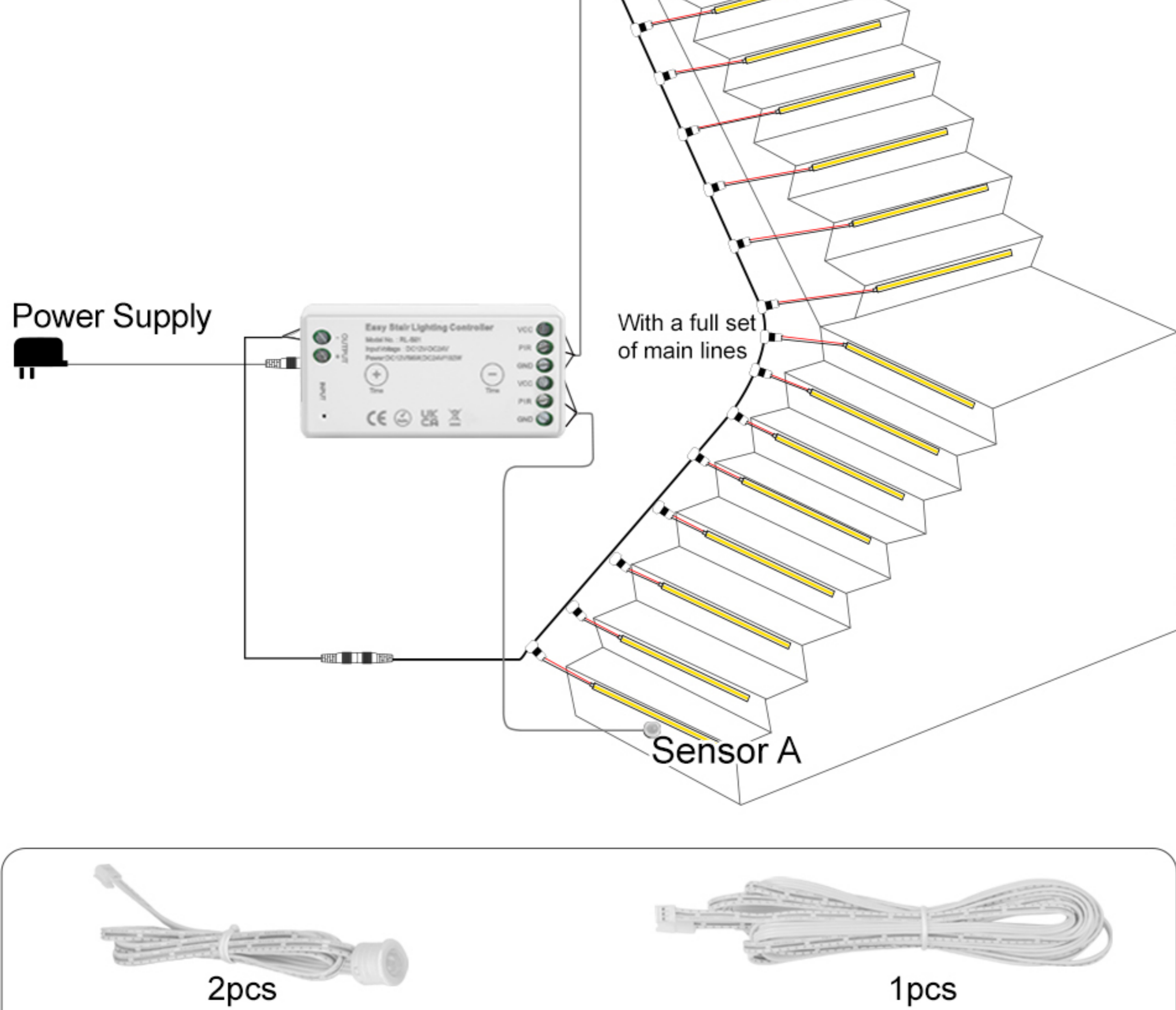

## How to use

### Step number

Easy series stair lighting controller work with main cable. If your stair have 16 steps, then use 16 steps main cable. If your stair have 20 steps, then use 20 steps main cable.



### Delay time

Touch "+" and "-" to adjust delay time

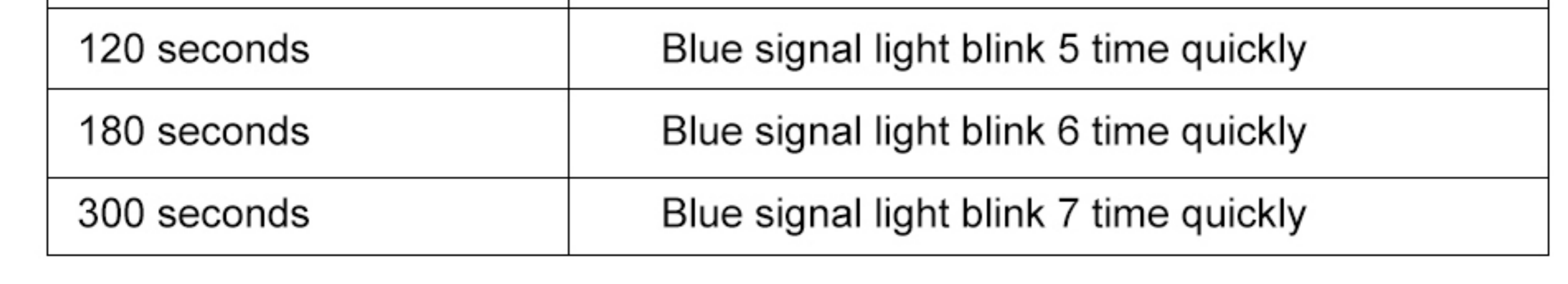

20 seconds delay time	Blue signal light blink 2 times quickly
40 seconds	Blue signal light blink 3 time quickly
60 seconds	Blue signal light blink 4 time quickly
120 seconds	Blue signal light blink 5 time quickly
180 seconds	Blue signal light blink 6 time quickly
300 seconds	Blue signal light blink 7 time quickly

### Tuya Control

Use Tuya app to control the brightness

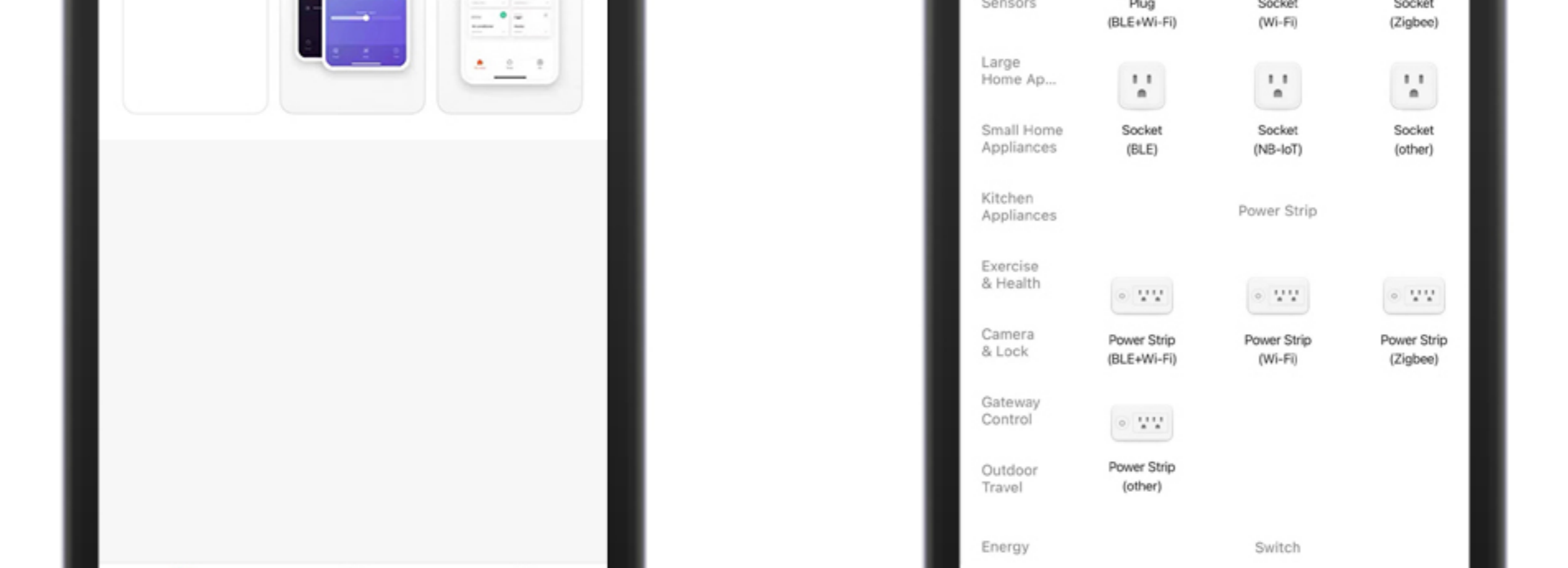

A. Download Tuya app      B. Scan device

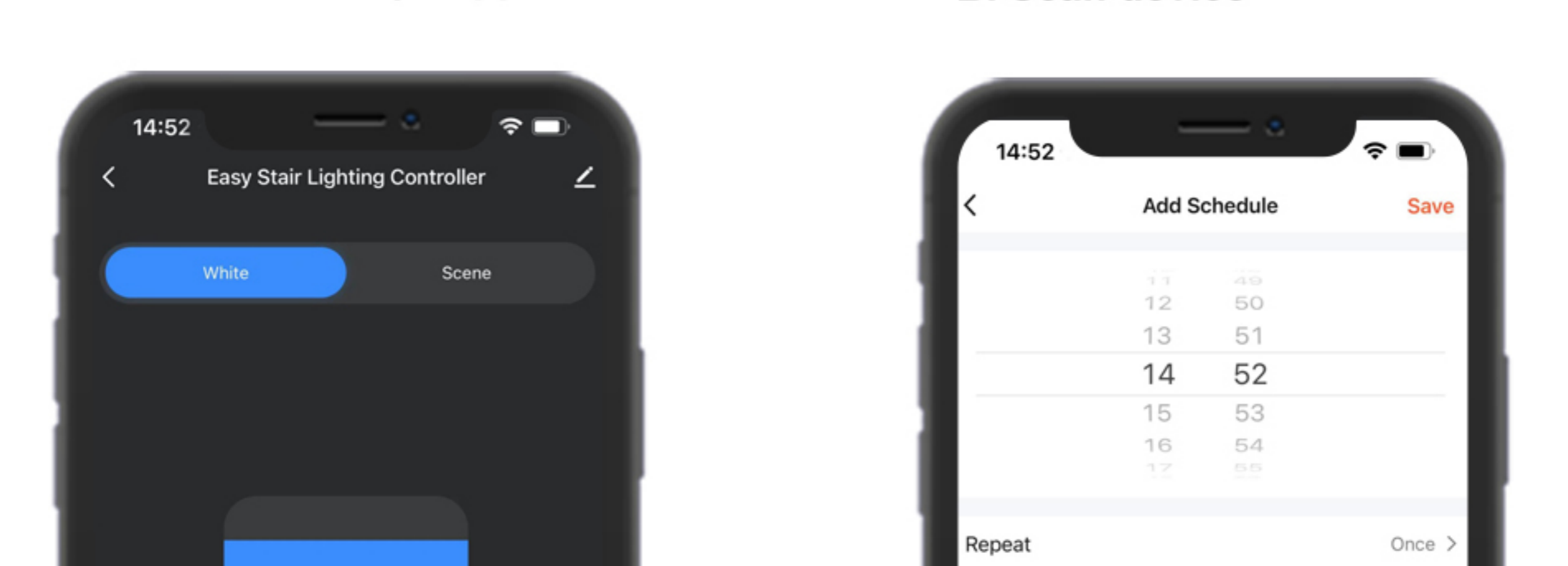

C. Adjust brightness      D. Timer

We can set the time to turn on or turn off the stair lighting

## Product Details

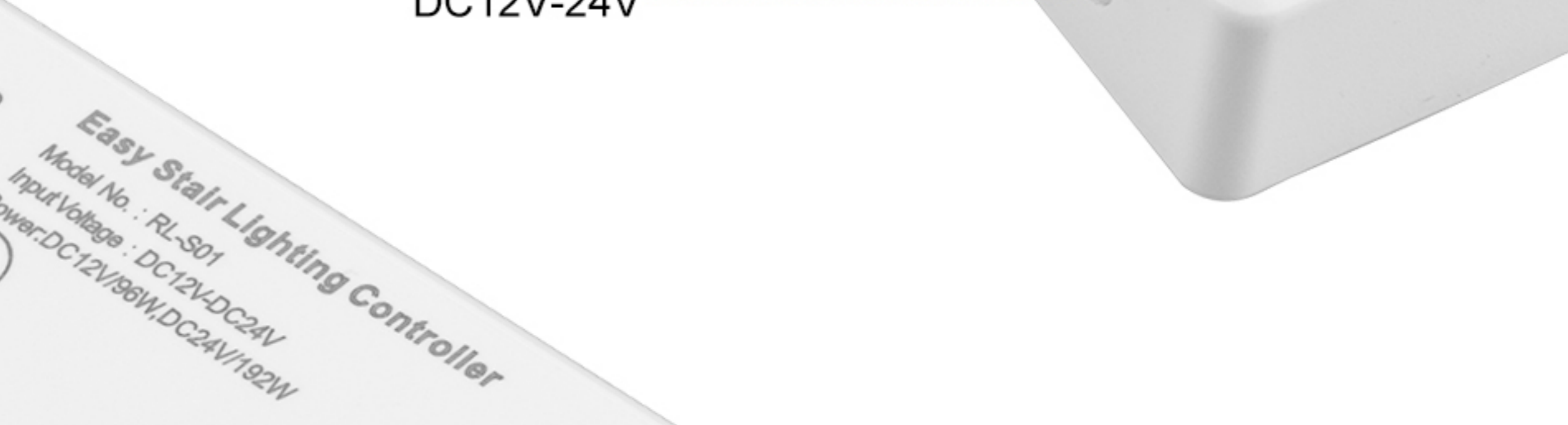
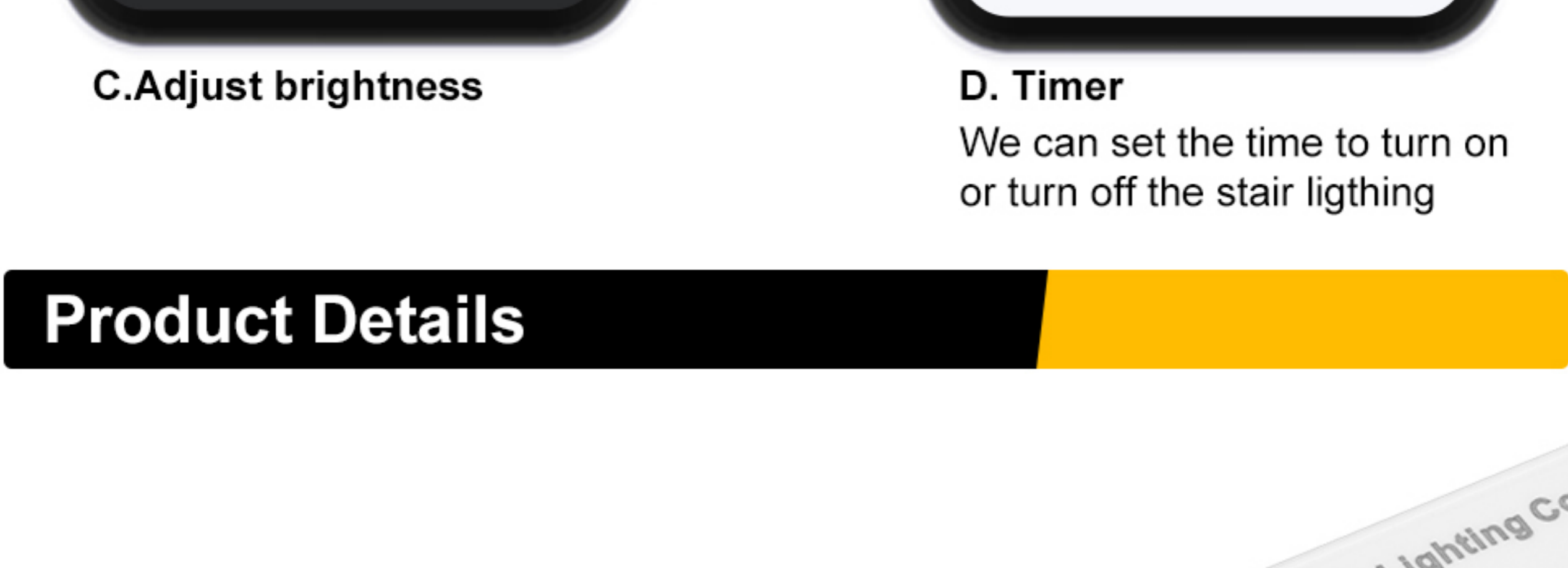

## Application

