

RF+Sensor Synchronous CCT 6 CH LED Control Box

Model No.: CV2

Features

- Only apply to 2-wires WW+CW LED strip
- Dimming interface: RF Wireless, Sensor
- Match with RF 2.4G single zone or multiple zone dual color remote control
- Match with a variety of induction sensor head
- 12VDC Input
- 6 channel synchronous CCT constant voltage output, Max. total output power 60W
- Ultra-thin design, light weight and high efficiency
- Light on/off fade time 3s selectable
- Suitable for indoor LED lighting application
- 5 Year, 50,000hr warranty

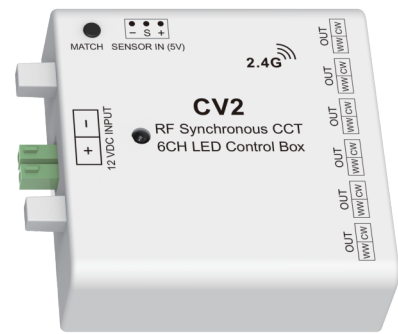

Applications

- Suitable for cabinet LED strip.

Mechanical Structures and Installations

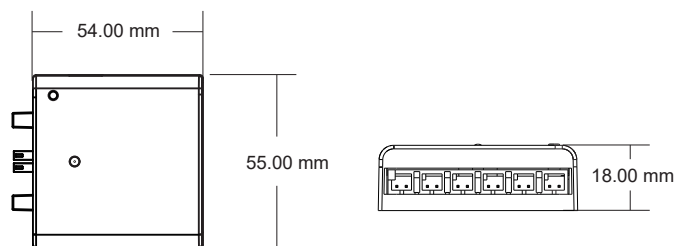
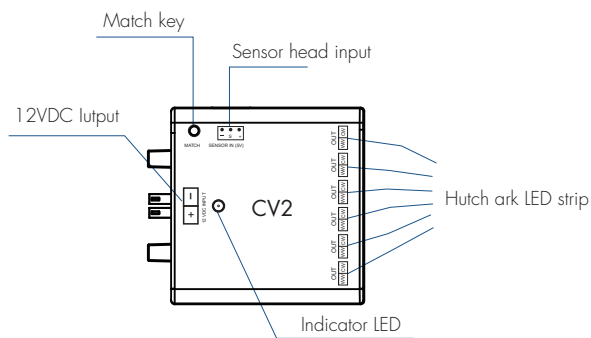

Wiring Diagram



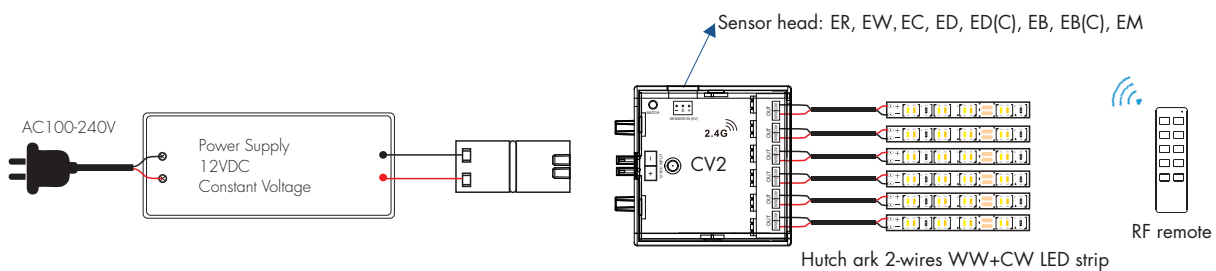



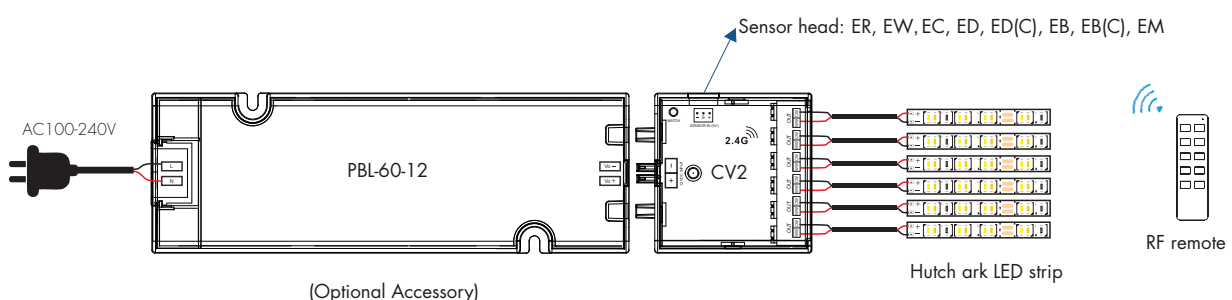

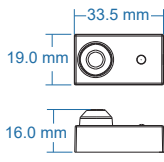

1. Use alone, powered by switching power supply

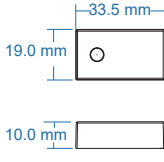

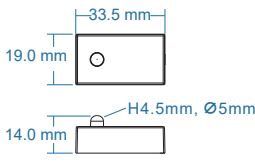
2. Matching hutch ark LED driver use

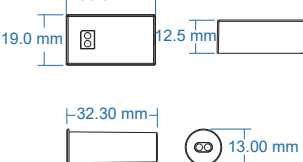

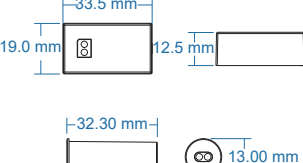
Available sensor head

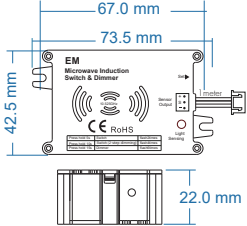
Model and Product name	Features	Product picture	Size	Sensor data
ER PIR Motion Sensor	When people or objects enter the sensitive field, the light turn on; when these exit the sensitive field, the light turn off after 30 seconds.			Sensitive field: $\leq 3m$ Sensitivity angle: 120
EW Wood Touch Sensor	The medium can be wood, glass or plastic. Short touch the sensing area to turn on or turn off light; long touch the sensing area to dimming up or down.			Dimming range: 0-100% PWM Frequency: 2KHz Detective distance: $\leq 5cm$
EC Touch Sensor	Short touch the LED to turn on or turn off light; long touch the LED to dimming up or down.			Dimming range: 0-100% PWM Frequency: 128Hz
ED ED(C) Door Sensor	When the door open, or no obstacle ahead, the light turn on gradually; when the door close, or obstacle ahead, the light turn off gradually.			Detective distance: $\leq 10cm$ Detective angle: 15-30
EB EB(C) Hand Sweep Sensor	When hand sweep, the light turn on gradually; when hand sweep again, the light turn off gradually.			Detective distance: $\leq 8cm$ Detective angle: 15-30
EM Microwave motion Sensor	Turns on the light upon detection of motion, and turns off after a pre-selected hold time when there is no movement.			Detection zone: Max.(DxH) 20 x 15m Detection angle: 150° (wall installation), 360° (ceiling installation) Hold time: 10s/30s/90s/3min/ 10min/20min/30min

Light on/off fade time

Long press match key 5s, then short press match key 3 times, the light on/off time will be set to 3s, the indicator light blink 3 times.

Long press match key 10s, restore factory default parameter, the light on/off time also restore to 0.5s.

Match Remote Control

The control box can match with RF 2.4G dual color remote control optional, except PIR motion sensor input.

For PIR motion sensor input, please long press the MATCH key 10s to disable the RF remote match function.

For other sensor input, please long press the Match key 5s to enable the RF remote match function.

The user can choose the suitable match/delete ways. Two options are offered for selection:

Use Match key

Match:

Short press match key, immediately press on/off key (single zone remote) or zone key (multiple zone remote) of the remote.

Delete:

Press and hold match key for 5s to delete all match, The light blinks 5 times means all matched remotes were deleted.

Use Power Restart

Match:

Switch off the power, then switch on power, repeat again. Immediately short press on/off key (single zone remote) or zone key (multiple zone remote) 3 times on the remote. The light blinks 3 times means match is successful.

Delete:

Switch off the power, then switch on power, repeat again. Immediately short press on/off key (single zone remote) or zone key (multiple zone remote) 5 times on the remote. The light blinks 5 times means all matched remotes were deleted.

Installation precautions

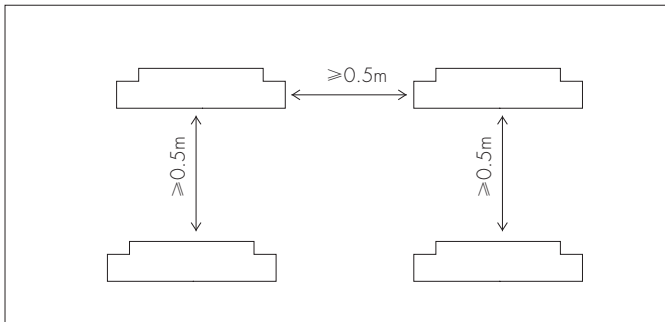

Please do not stack the products.

The distance between two products should be $\geq 0.5\text{m}$, so as not to affect heat dissipation and lifespan of the products.

Failure analysis and troubleshooting

fault	cause	solution
The light can not be turned on	<ol style="list-style-type: none"> no power Wrong wiring 	<ol style="list-style-type: none"> Check the power supply Connection test
Remote control nonresponse	<ol style="list-style-type: none"> run out of battery Beyond remote control range No matching 	<ol style="list-style-type: none"> Replace the battery Move the remote to controller closer Match the remote to LED driver
Hiccup flashing	Overload	Check the power of the light
Controlled by other remote	Wrong pairing	Delete all pairing and pair with remote again
Multiple LED drivers are out of sync	Inconsistent fade on/off time	Set the same fade on/off time