

# User Guide

## RGB+CCT LED Strip Controller Set

The RGB+CCT five color LED controller set is designed with ultra sensitive touch color wheel to adjust static RGB color or color temperature fast and accurately. Independent dimming function of each R, G, B channel to achieve millions of colors. Built-in 10 dynamic mode can create fancy lighting effects, also you can save scene what you like.

### Feature

- Mini style controller with 5 channel constant voltage output (R/G/B/WW/CW).
- Smooth dimming and switch without any flickering.
- Built in 10 dynamic mode, include jump or gradual change style.
- Adopt 2.4GHz wireless technology, remote distance up to 30m.
- Auto-transmitting function, one receiver can transmit the signal from the remote to another receiver within 15m, so the remote control distance can be beyond 100m.
- Auto-synchronization function, different receivers can work synchronously when they are controlled by the same remote, under same dynamic mode and same speed.
- Work with power repeater to expand output unlimitedly.

### Technical parameter

#### LED Remote

- Output signal: RF(2.4GHz)
- Working voltage : 3VDC(CR2032)
- Standby time: 1 year
- Remote distance: 30m
- Size: L107×W58.5×H9mm

#### Dimension

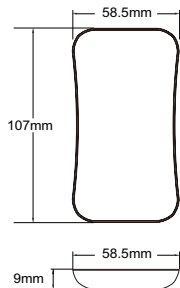

#### LED Receiver

- Input voltage: 12-24VDC
- Output type: PWM constant voltage
- Output current: 5CH, 3A/CH, Total max 15A
- Output power: 180-360W
- Size: L114×W38×H20mm

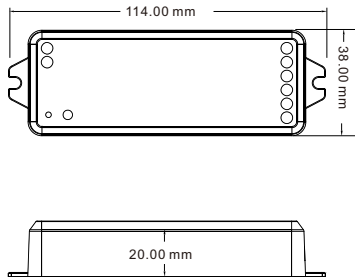

### Remote function

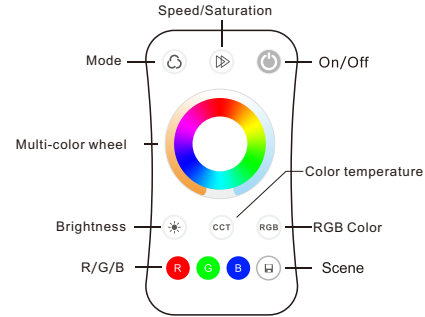

**On/Off:** Short press turn on/off light.

**Mode:** Switch dynamic mode, short press run the next mode, long press 2s run mode cycle.

**Speed/Saturation:**

For dynamic RGB mode, adjust mode speed, short press 10 levels, long press 2s get the default speed.

For static RGB color, adjust saturation, namely change current static color to mixed white slowly, short press 11 levels, long press 1-5s for continuous 256 levels adjustment.

**Brightness:** Adjust brightness, short press 11 levels, long press 2s get max or min brightness. at the same time, multi-color wheel become brightness wheel.

**CCT:** Adjust color temperature, short press 11 levels, long press adjust WW+CW brightness. at the same time, multi-color wheel become color temperature wheel.

Adjust color temperature by WW/CW channel.

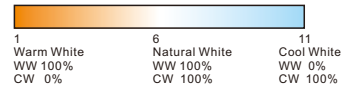

**RGB:** Adjust static RGB color, short press get 24 kinds static color. at the same time, multi-color wheel become RGB color wheel.

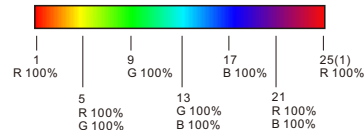

**R/G/B:** Short press get red, green or blue color directly. long press 1-5s to adjust R/G/B brightness continuously.

**Scene:** Short press recall the scene, long press 2s save current color into the scene.

### Multi-color wheel:

When it is **brightness** wheel, touch to change brightness.

When it is **color temperature** wheel, touch to change color temperature.

When it is **RGB color** wheel, touch to change RGB color.

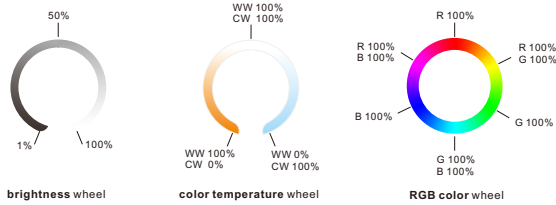

## Match guide

### Use Match key

1. Match: Short press match key of the receiver, within 5s, press on/off key of the remote.
2. Delete: Long press match key of the receiver for 5s, delete all matched remote.

### Use Power-up

1. Match: Switch off the power, then switch on power again, short press on/off key 3 times on the remote quickly within 5s after power on, the link is done once the light blinks 3 times.
2. Delete: Switch off the power, then switch on power again, short press on/off key 5 times on the remote quickly within 5s after power on, the unlink is done once the light blinks 5 times.

## Wiring diagram

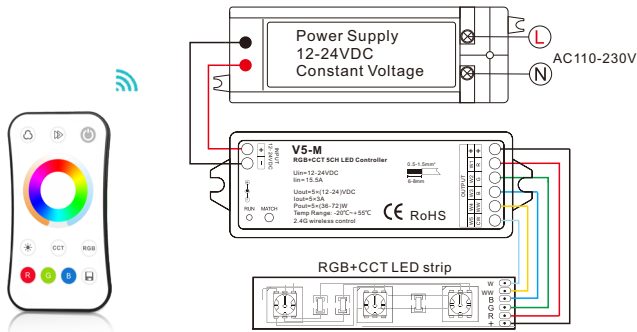

## Dynamic mode list

No.	Name	No.	Name
1	RGB jump	6	RGB fade in and out
2	RGB smooth	7	Red fade in and out
3	6 color jump	8	Green fade in and out
4	6 color smooth	9	Blue fade in and out
5	Color temperature smooth	10	White fade in and out

## Malfunctions analysis & troubleshooting

Malfunctions	Causes	Troubleshooting
No light	1. No power. 2. Wrong connection or insecure.	1. Check the power. 2. Check the connection.
Wrong color	1. Wrong connection of R/G/B/WW/CW wires.	1. Reconnect R/G/B/WW/CW wires.
Uneven intensity between front and rear, with voltage drop	1. Output cable is too long. 2. Wire diameter is too small. 3. Overload beyond power supply capability. 4. Overload beyond controller capability.	1. Reduce cable or loop supply. 2. Change wider wire. 3. Replace higher power supply. 4. Add power repeater.
No response from the remote	1. The battery has no power. 2. Beyond controllable distance. 3. The controller did not match the remote.	1. Replace battery. 2. Reduce remote distance. 3. Re-match the remote.

## Safety information

1. The product shall be installed and serviced by a qualified person.
2. This product is non-waterproof. Please avoid the sun and rain.
3. Good heat dissipation will prolong the working life of the controller, please ensure good ventilation.
4. Please check if the output voltage of any power supplies used comply with the working voltage of the product.
5. Ensure all wire connections and polarities are correct and secure before applying power to avoid any damages to the LED lights.
6. If a fault occurs please return the product to your supplier. Do not attempt to fix this product by yourself.