

WiFi & RF 5 in 1 LED Controller

Model No.: WT5

Tuya APP cloud control/Voice control/5 Channels/1-5 color/DC power socket input/Wireless remote control

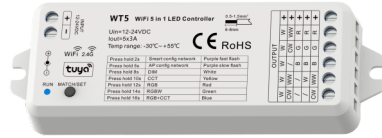

FC CE RoHS LVD RED

Features

- 5 in 1 function, used for control RGB, RGBW, RGB+CCT, color temperature or single color LED strip.
- DC power socket input and 5 channel constant voltage output.
- Tuya APP cloud control, support on/off, RGB color, color temperature and brightness adjust, delay turn on/off light, timer run, scene and music play function.
- Voice control, support amazon ECHO and TmallGenie smart speaker.
- Match with RF 2.4G remote control optional.
- User need set light type by press key before Tuya APP network connection and match RF remote of the same light type.
- Each WT5 controller can also work as WiFi to RF converter, then use Tuya APP to control one or more RF LED controller or RF LED dimming driver synchronously.

Technical Parameters

Input and Output	
Input voltage	12-24VDC
Input current	15.5A
Output voltage	5 x (12-24)VDC
Output current	5CH, 3A/CH
Output power	5 x (36-72)W
Output type	Constant voltage

Dimming data	
Input signal	Tuya APP + RF 2.4GHz
Control distance	30m(Barrier-free space)
Dimming gray scale	4096 (2^12) levels
Dimming range	0-100%
Dimming curve	Logarithmic
PWM Frequency	500Hz (default)

Safety and EMC	
EMC standard [EMC]	EN55015, EN61547
Safety standard[LVD]	EN61347, EN62493
Radio Equipment[RED]	EN300 440, EN50663, EN301 489
Certification[CE-RED]	Safety+EMC+RF

Environment	
Operation temperature	Ta: -30°C ~ +55°C
Case temperature (Max.)	Tc: +85°C
IP rating	IP20

Warranty and Protection	
Warranty	5 years
Protection	Reverse polarity Over-heat

Mechanical Structures and Installations

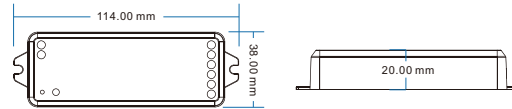
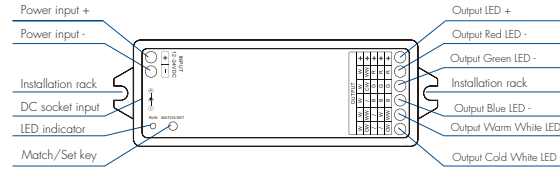

System wiring

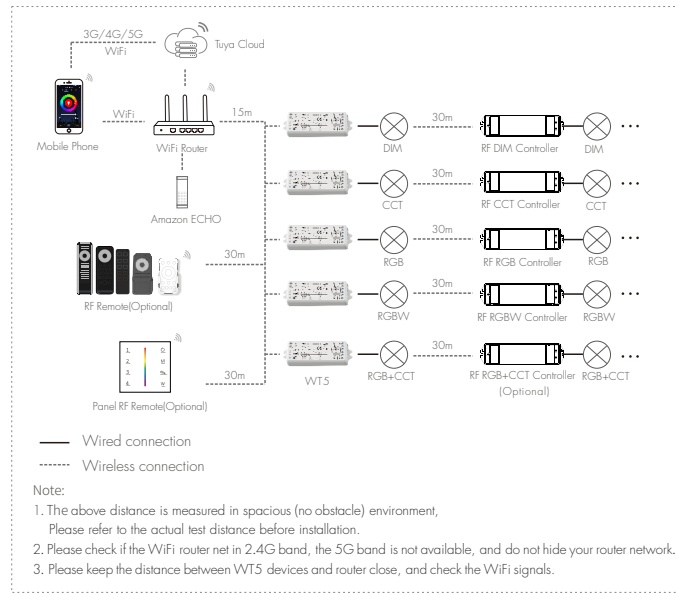

Wiring Diagram

• For RGB+CCT

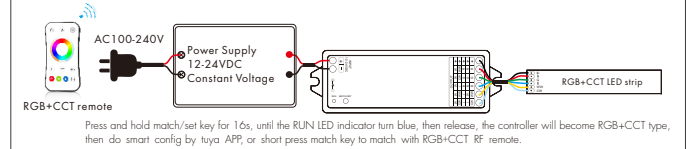

• For RGBW

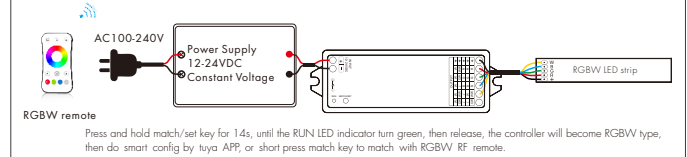

• For RGB

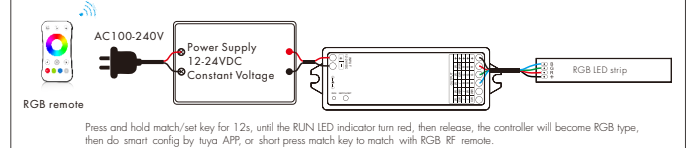

• For dual color CCT

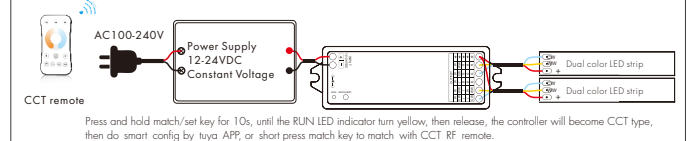

• For single color

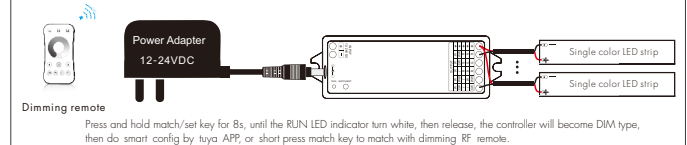

Note: User can connect constant voltage power supply or power adapter as power input.

Tuya APP network connection

Press and hold Match/Set key for 2s, or push twice Match/Set key firstly, or when press and hold Match/Set key for 8-10s to set 5 kinds light type:
Clear previous network connection, enter Smart config mode, the purple LED indicator fast flash.

Press and hold Match/Set key for 5s:
Clear previous network connection, enter AP config mode, the purple LED indicator fast slow.
If smart config failed, please try AP config.

If Tuya APP network connection succeed, the RUN LED indicator will stop flash purple, and turn corresponding light type color (White: DIM, Yellow: CCT, Red: RGB, Green: RGBW, Blue: RGB+CCT).
and in Tuya APP, you can find SKYDANCE-RGB+CCT device (or other DIM, CCT, RGB or RGBW).

Tuya APP interface

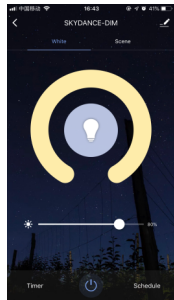

White interface

For DIM type:
Touch brightness slide to adjust brightness.

For RGB type:
Touch brightness slide, get RGB mixed white firstly, then to adjust white brightness.

For RGBW type:
Touch brightness slide, adjust white channel brightness.

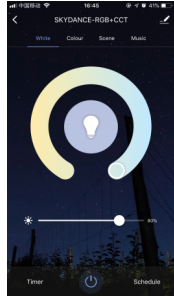

Color temperature interface

For CCT type:
Touch color wheel to adjust color temperature.
Touch brightness slide to adjust brightness.

For RGB+CCT type:
Touch color wheel to adjust color temperature, RGB will turn off automatically.
Touch brightness slide to adjust white brightness.

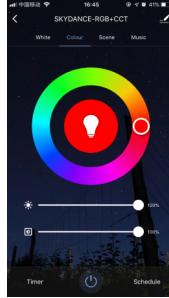

Colour interface

For RGB or RGBW type:
Touch color wheel to adjust static RGB color.
Touch brightness slide to adjust color brightness.
Touch saturation slide to adjust color saturation, namely gradient from the current color to white[RGB mixed].

For RGB+CCT type:
Touch color wheel to adjust static RGB color, WW/CW will turn off automatically.
Touch brightness slide to adjust color brightness.
Touch saturation slide to adjust color saturation, namely gradient from the current color to white [RGB mixed].

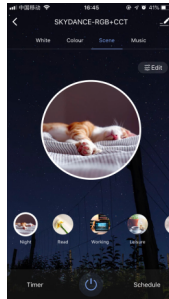

Scene interface

The 1-4 scene is static color for all light type.
the inner color of these scene can be editable.

The 5-8 scene is dynamic mode for RGB, RGBW, RGB+CCT type,
such as green fade in and fade out, RGB jump, 6 color jump, 6 color smooth.

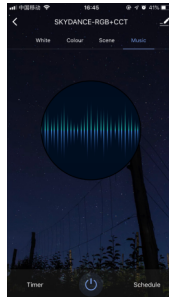

Music, Timer, Schedule

The music play can use smart phone music player or microphone as music signal input.

The Timer key can turn on or turn off light in the next 24 hours.

The Schedule key can add multiple timers to turn on or turn off light according to different time periods.

WT5 match remote control (Optional)

End user can choose the suitable match/delete ways. Two options are offered for selection:

Use the controller's Match key

Match:
Short press match key, immediately press on/off key (single zone remote) or zone key (multiple zone remote) on the remote.
The LED indicator fast flash a few times means match is successful.

Delete:
Press and hold match key for 20s to delete all match,
The LED indicator fast flash a few times means all matched remotes were deleted.

Use Power Restart

Match:
Switch off the power, then switch on power again, immediately short press on/off key (single zone remote) or zone key (multiple zone remote) 3 times on the remote.
The light blinks 3 times means match is successful.

Delete:
Switch off the power, then switch on power again, immediately short press on/off key (single zone remote) or zone key (multiple zone remote) 5 times on the remote.
The light blinks 5 times means all matched remotes were deleted.

WT5 work as WiFi to RF converter to match RF LED controller or dimming driver

End user can choose the suitable match/delete ways. Two options are offered for selection:

Use the controller's Match key

Match:
Short press match key, immediately press on/off key on the Tuya APP.
The LED indicator fast flash a few times means match is successful.

Delete:
Press and hold match key for 20s to delete all match,
The LED indicator fast flash a few times means all matched remotes were deleted.

Use Power Restart

Match:
Switch off the power, then switch on power again, immediately short press on/off key 3 times on the Tuya APP.
The light blinks 3 times means match is successful.

Delete:
Switch off the power, then switch on power again, immediately short press on/off key 5 times on the Tuya APP.
The light blinks 5 times means all matched remotes were deleted.

RGB dynamic mode list

For RGB/RGBW:

No.	Name	No.	Name
1	RGB jump	6	RGB fade in and out
2	RGB smooth	7	Red fade in and out
3	6 color jump	8	Green fade in and out
4	6 color smooth	9	Blue fade in and out
5	Yellow cyan purple smooth	10	White fade in and out

For RGB+CCT:

No.	Name	No.	Name
1	RGB jump	6	RGB fade in and out
2	RGB smooth	7	Red fade in and out
3	6 color jump	8	Green fade in and out
4	6 color smooth	9	Blue fade in and out
5	Color temperature smooth	10	White fade in and out