

## 24V CSP Pixel RGB LED Strip

### PRODUCT SPECIFICATION



### Key Feature

- ◆ CSP LED Strip (new generation)
- ◆ Real RED, and GREEN, and BLUE color
- ◆ Alternative COB Strip, and cost-effective
- ◆ New LED encapsulation technology (chip scale package technology)
- ◆ 50,000 hours Lifetime, 5 years warranty

RED: 620NM  
GREEN: 525NM  
BLUE: 454NM



New  
Chip Scale  
Package

5 years  
warranty  
Indoor only

## Drawing:

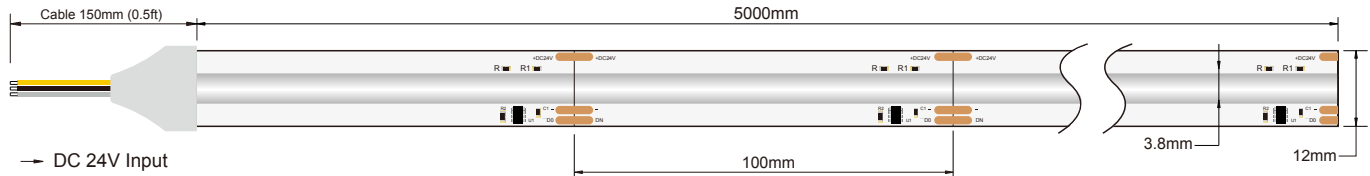

### Notice:

Safety Input Voltage: DC 24V

Size of each section is 100mm (3.94"), and cutting at "scissors symbol" place.

LED Strip length's length tolerance is  $\pm 0.2\%$ mm, width tolerance is  $\pm 0.2$ mm.

## Optical

LED type:	Flip Chip
Control Protocol:	SPI
CCT Range:	RGB
Irritation angle:	120°
Light Efficiency:	31 Lm/w
Lumen output/meter:	372Lm/m (113LM/ft)

## Electric (24V)

Input current/m:	0.5A/m
Input Voltage:	DC24V
Voltage Power/m:	12W/m
Static Electricity:	1000V(ESD)
LEDs/meter:	720/m
Size of section:	100mm (3.94")
LEDs of section:	72LEDs

## Others

Energy grade:	N/A
Warranty:	5years
Working hour:	50,000hrs lifetime for $T_c < 70^\circ$
Working temperature:	C $-20^\circ\text{C} \sim +45^\circ\text{C}$
Working humidity:	40%-70%RH
Measurement:	L5000*W10mm
Waterproof Rate:	IP20

## Descriptions:

- ◆ LED Strip can be used in many kinds of places as decorative lighting/backlight/, such as Ceiling trough, Staircase, Hall walkway, Billboard, Advertising sign, Bridge, Shopwindow, Cabinet etc. ;
- ◆ LED Project Strip can be 30m/roll, or 40m/roll Packaging. 100% of the lamps will be tested and keep lighting for 24h testing its quality reliability, and we also test it temperature after 24 hours's lighting;
- ◆ We can provide with different Custom products, such as printing Customer LOGO on FPC, Custom Aluminum Foil Bag Custom carton box/connector/DC cable/, Customs FPC design/color/width etc.

## Waterproof Rate :

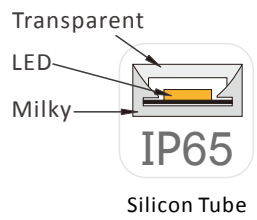
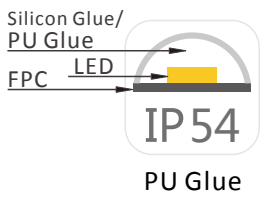
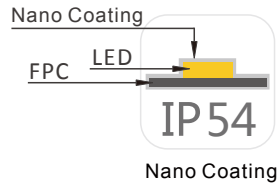
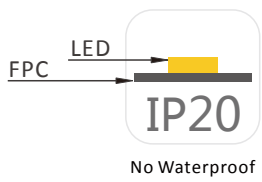

### IP Rate Description :

- IP20 : Indoor use
- IP54 Nano : No Color shift with high Color Consistency
- IP65 PU : No Lead and mercury, Strong adhesion
- IP65 Silicon : Anti-UV ability, never become yellow
- IP67 : Lead-free and mercury-free, Strong adhesion
- IP68 : Silicon glue with Anti-UV, never change color

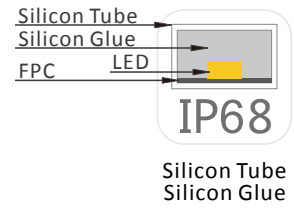
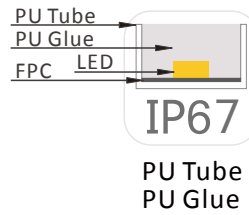

## Wiring diagram application :

- ◆ Single end power input for 5 meters

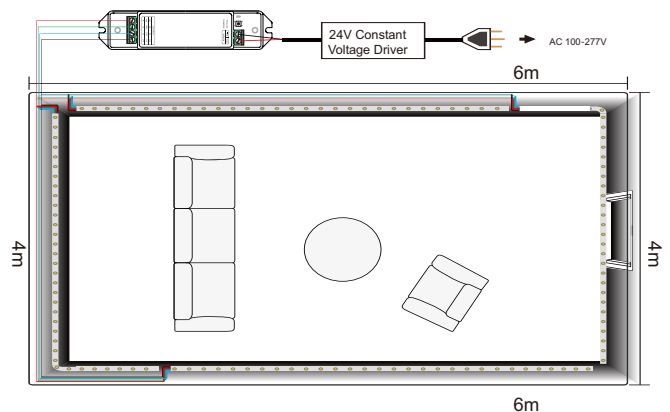
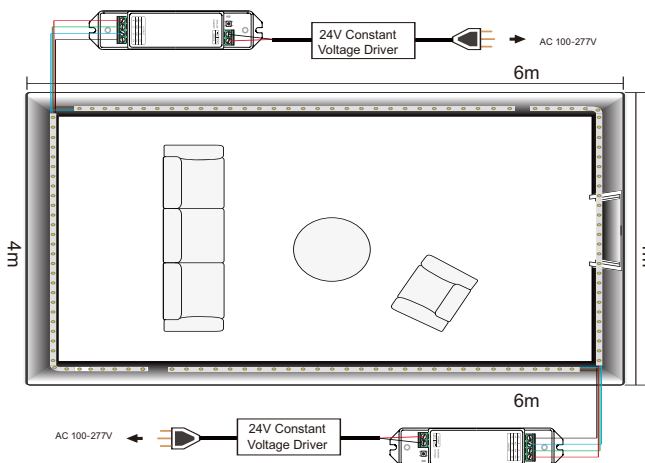
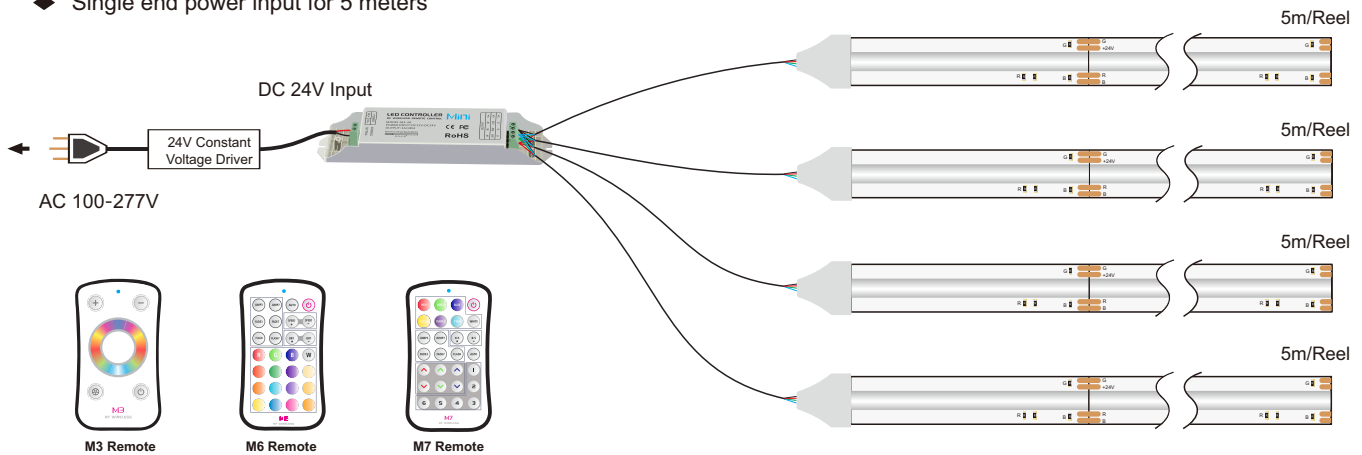

## 3M Adhesive Tape



3M 200 LSE Type  
(Economy Type)



3M 300 LSE Type  
(Mid-quality Type)



3M VHB RED  
(High-quality Type)

## Packaging

### Aluminium foil bag



### Plastic reel

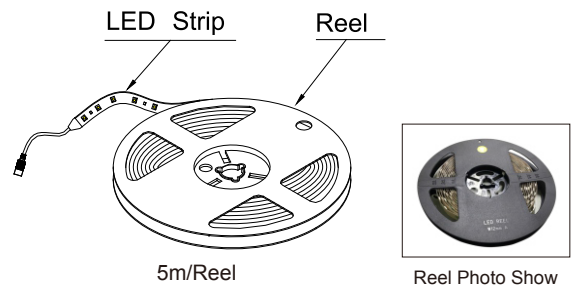

### Carton box

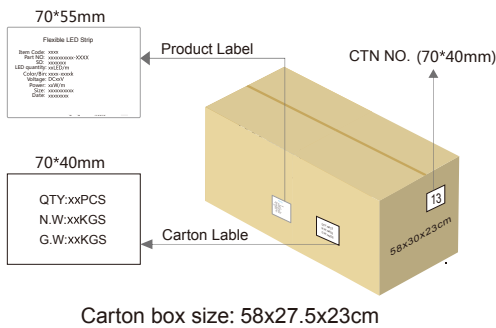

### Packing Number

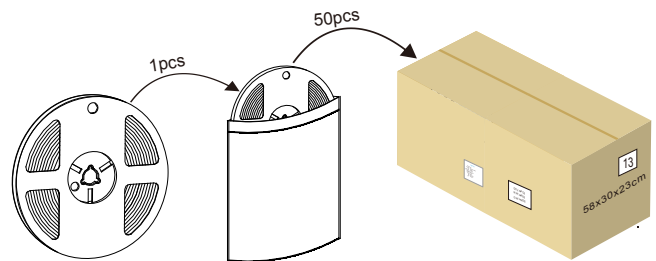

## Strip Code :

Product series	Item code	Number of LED (m)	Voltage (DC)	Power/watt (W/m) (W/ft)	Color	Wavelength (NM)	Lumens Output (Lm/m) (Lm/ft)	IP Grade
RGB Pixel	310A720A00-D 000A1A10	720LEDs	24V	12W 3.6W	RGB	/	376 Lm 114 Lm	IP20
		240LEDs	24V	5.4W 1.6W	RED	620 NM	41 Lm 12.5 Lm	IP20
		240LEDs	24V	5.4W 1.6W	GREEN	525 NM	287 Lm 87.5 Lm	IP20
		240LEDs	24V	5.4W 1.6W	BLUE	454 NM	50 Lm 15.3 Lm	IP20

## Cautions:

≤50 mm diameter of wrapped object prohibited

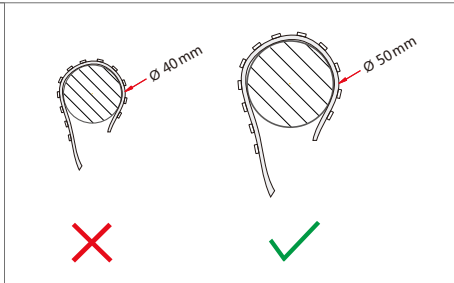

Touching LED, pls wear the electrostatic ring for avoiding ESD

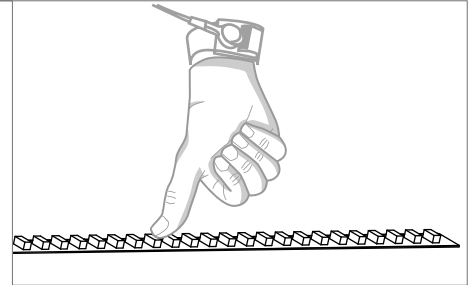

## Safety Information

Application notes for led flexible strip

**In order to drive LED flexible strip lights safely, it is absolutely necessary to operate them with an electronically stabilised power supply protecting against short circuits, overload and overheating.**

**To also ease the luminaire/installation approval, electronic control gear, power supply and all electronic accessories for LED or LED modules should carry "CE, or UL" mark and meet the latest safety standard.**

- Please use 24VDC isolated power supply to drive the led strip, and the constant voltage source ripple less than 5%. Can't step-down the power by resistance-capacitance and non-isolated power supply driver led strip, etc.
- To ensure the longevity and reliability of the strips, please do not bend the arc diameter 60mm or less, do not fold to avoid damaging the lamp beads or broken.
- To ensure the life and environment of lights, in the use of force can not pull the power cord to avoid damage to prohibit collision LED lights.
- During the installation of positive and negative attention to the power cord, do not pick the wrong voltage power supply and the product are the same, so as to avoid damage to the product.
- LED lights should be stored in dry sealed environment, the proposed storage period should not be too long before using unpacking, the working temperature: -20 ~ + 45 , Storage temperature: -0 ~ + 60 , not waterproof lights band indoor use, relative humidity not higher than 70%.
- In practical applications, the power supply should leave 20% margin (recommend using only 80% of the power) in order to ensure a sufficient amount of voltage drive products
- Do not use any acidic, alkaline adhesive securement products (including not limited to glass, plastic, etc.)