

Intelligent Tunable White LED Driver (Constant Current)

- Small size and light weight. The housing is made from V0 flame retardant PC materials that SAMSUNG/COVESTRO uses.
- Use Zigbee protocol and Tuya application protocol with high networking capability.
- T-PWM™ dimming technology allows continuous and flicker-free images under high-speed photography.
- With soft-on and fade-in dimming function, enhancing your visual comfort.
- Dimming from 0-100%, down to 0.1%.
- The whole dimming process is flicker-free with high frequency exemption level.
- Multiple current levels and wide voltage range. Suitable for different power of LEDs.
- Innovative thermal management technology intelligently protects the life of the LED driver.
- Overheat, over voltage, overload, short circuit protection and automatic recovery.
- Up to 50,000-hour life time.
- 5-year warranty (Rubycon capacitor).



T-PWM™
Dimming technology

Flicker-Free
IEEE 1789

Dimmable:
0.1% - 100%



RoHS

SELV

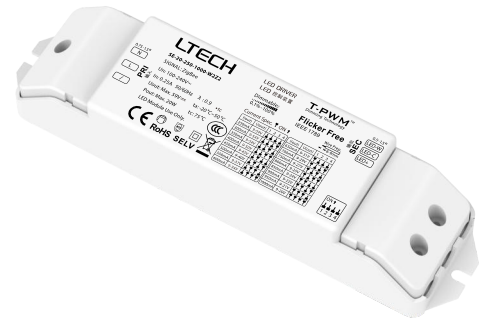

Technical Specs

Model	SE-20-250-1000-W2Z2			
Features	Output Type	Constant Current		
	Dimming Interface	Zigbee		
	Output Feature	Isolation		
	Protection Grade	IP20		
OUTPUT	Insulation Grade	Class II (Suitable for class I / II / III light fixtures)		
	Output Voltage	Max. 59Vdc		
	Output Voltage Range	9-54Vdc		
	Output Current	250-1000mA		
	Output Power	Max. 20W		
	Output Power Range	0-20W		
	Strobe Level	High frequency exemption level		
	Dimming Range	0-100%, down to 0.1%		
	Overload Power Limitation	≥102%		
INPUT	Ripple	≤2V		
	PWM Frequency	≤3600Hz		
	DC Voltage Range	120-300Vdc		
	AC Voltage Range	100-240Vac		
	Rated Voltage	115Vac, 230Vac		
	Frequency	50/60Hz		
	Input Current	115Vac≤0.25A, 230Vac≤0.13A		
	Power Factor	PF≥0.95/115Vac, PF≥0.90/230Vac (at full load)		
	THD	THD≤10%@230Vac (at full load)		
	Efficiency (typ.)	83%		
	Standby power consumption	<0.5W		
ENVIRONMENT	Inrush Current	Cold start 10A@230Vac (Test twidth=40us tested under 50% Ipeak)		
	Anti Surge	L-N: 2kV		
	Leakage Current	<0.24mA/230Vac		
	Working Temperature	ta: -20 ~ 50°C tc: 75°C		
PROTECTION	Working Humidity	20 ~ 95%RH, non-condensing		
	Storage Temperature/Humidity	-40 ~ 80°C, 10-95%RH		
	Temperature Coefficient	±0.03%/°C (0-50°C)		
	Vibration	10-500Hz, 2G 12min/1cycle, 72 min for X, Y and Z axes respectively		
SAFETY & EMC	Overheat Protection	Intelligently adjust or turn off the output current if the PCB temperature ≥110°C, and recover automatically		
	Overload Protection	Shut down the output when current load ≥102%, and recover automatically		
	Short Circuit Protection	Enter hiccup mode if short circuit occurs, and recover automatically		
	Overvoltage Protection	When the voltage exceeds the no-load voltage, it will be protected and automatically recovered		
OTHERS	Withstand Voltage	I/P-O/P: 3750Vac		
	Isolation Resistance	I/P-O/P: 100MΩ/500VDC/25°C/70%RH		
	Safety Standards	CCC	China	GB19510.1, GB19510.14
	EMC Emission	CCC	China	GB/T17743, GB17625.1
	EMC Immunity	EN61000-4-2,3,4,5,6,8,11, EN61547		
OTHERS	Strobe Test Standard	IEEE 1789		
	Life Time	50000 hours		
Warranty	5 years			

LED Current Selection



DIP switch quickly selects multiple current value (See the table below). ▲ Please set current value when the driver is power-off

SE-20-250-1000-W2Z2	DIP switch									ON
	Output current	250mA	300mA	350mA	400mA	450mA	500mA	550mA	600mA	
	Output voltage	9-54V	9-54V	9-54V	9-50V	9-45V	9-40V	9-37V	9-34V	
	Output power	2.25-13.5W	2.7-16.2W	3.15-18.9W	3.6-20W	4.05-20.25W	4.5-20W	4.95-20.35W	5.4-20.4W	
	DIP switch									
	Output current	650mA	700mA	750mA	800mA	850mA	900mA	950mA	1000mA	OFF
	Output voltage	9-31V	9-29V	9-27V	9-25V	9-24V	9-22V	9-21V	9-20V	
	Output power	5.85-20.15W	6.3-20.3W	6.75-20.25W	7.2-20W	7.65-20.4W	8.1-19.8W	8.55-19.95W	9-20W	

Product Size

Unit: mm

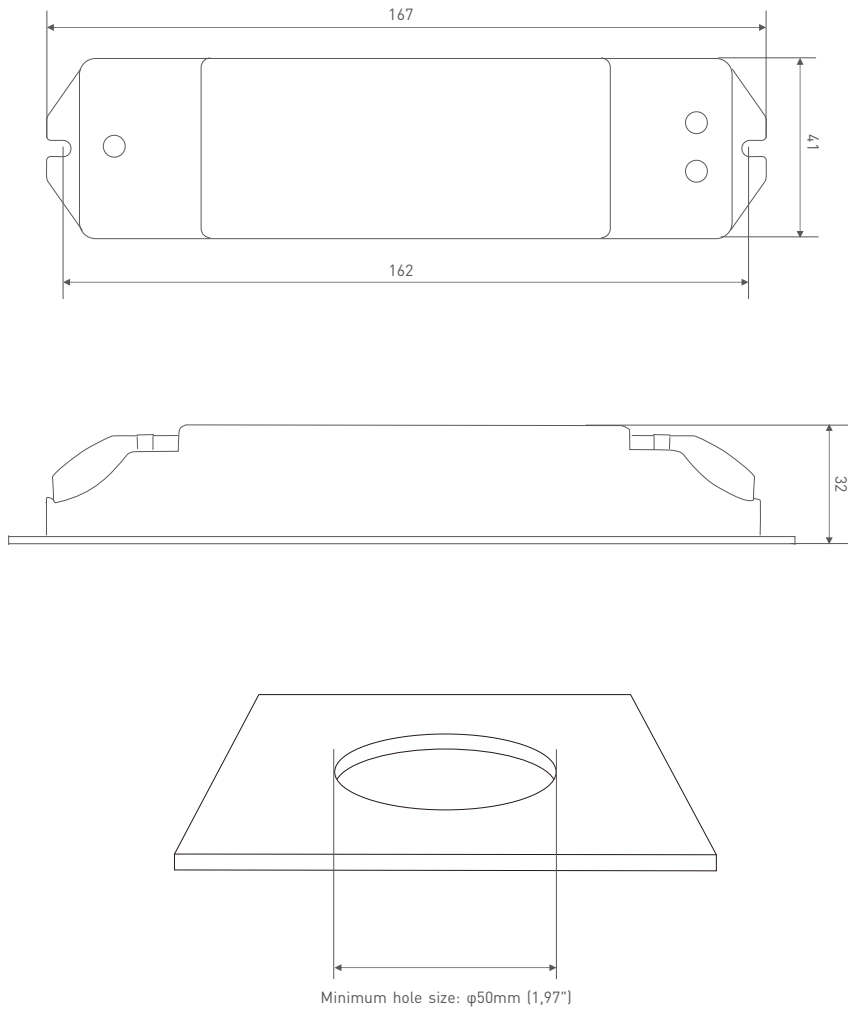

Wiring Diagram

Wireless connection

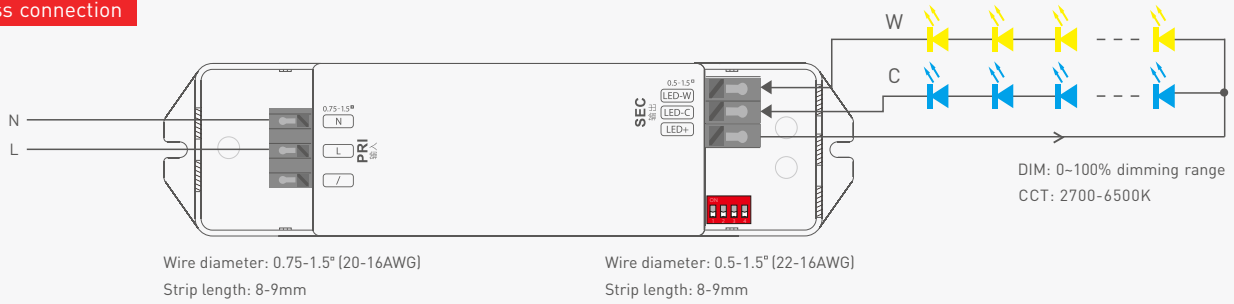

Four-wire LED lamp connection

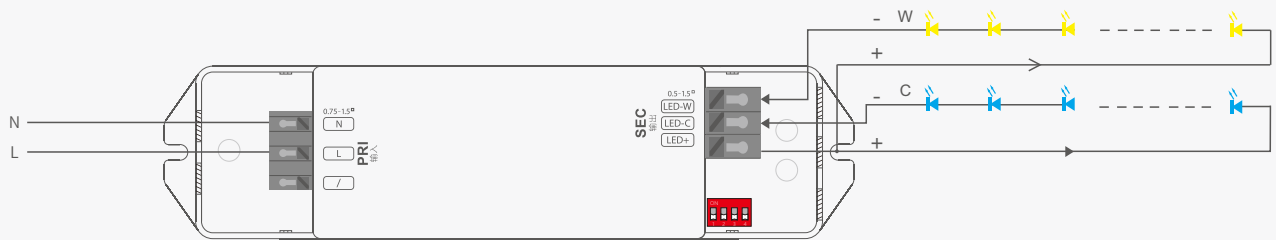

* Adopt constant power program design and it keeps the same brightness in color temperature adjustment.
Twice the rated power load can be connected to the driver. A 20W driver can connect to 20W X 2CH load and the total power of the 2 channels will be kept within 20W.

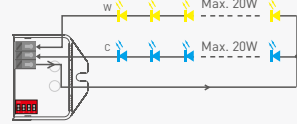

Installation Precautions

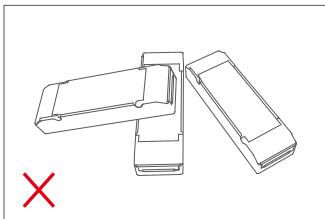

Please do not stack the products. The distance between two products should be $\geq 15\text{cm}$ so as not to affect heat dissipation and the lifespan of the products.

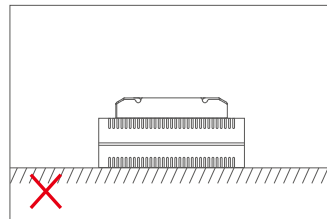
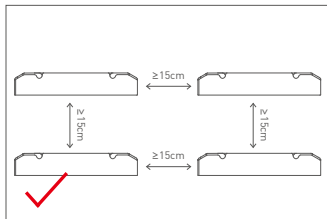

Please not place the products on LED drivers. The distance between the product and the driver should be $\geq 15\text{cm}$ so as not to affect heat dissipation and shorten the lifespan of the products.

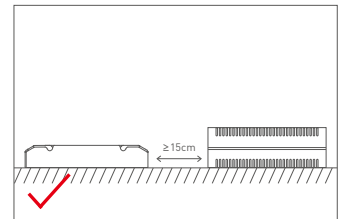

App Operating Instructions

1. Register an account

Tuya Smart App is compatible with iOS and Android systems. Scan the QR code below with you mobile phone and follow the prompts to complete the app installation. After installation being completed, you can log in or register an account.

APP support



App download

2. Paring instructions

A new user clicks "Me" → "Home Management" → "Create a Home", give a name to your home and confirm your home location, Then click "My Home" to add devices. After you enable appropriate permissions, click "+" icon → "Auto Scan" and the available Bluetooth/Wi-Fi/Zigbee/wired devices will be automatically found. Follow the prompts to add the device. (Please ensure that the device is ready for network connection).

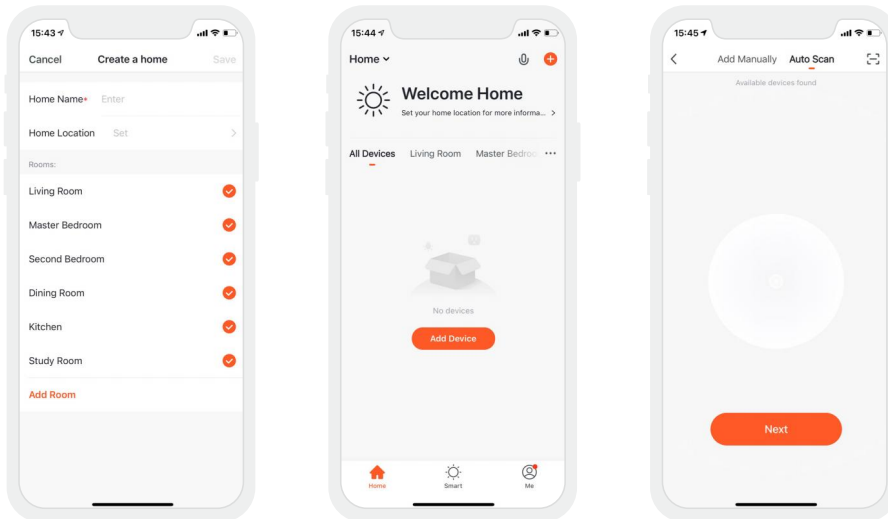

3. Lighting control settings

After paring up your device, click the device you add and adjust to your desired lighting status by changing brightness and color temperature. In "Settings", there are also lighting alarm clock and countdown functions (Tuya Zigbee Gateway needs to be added).

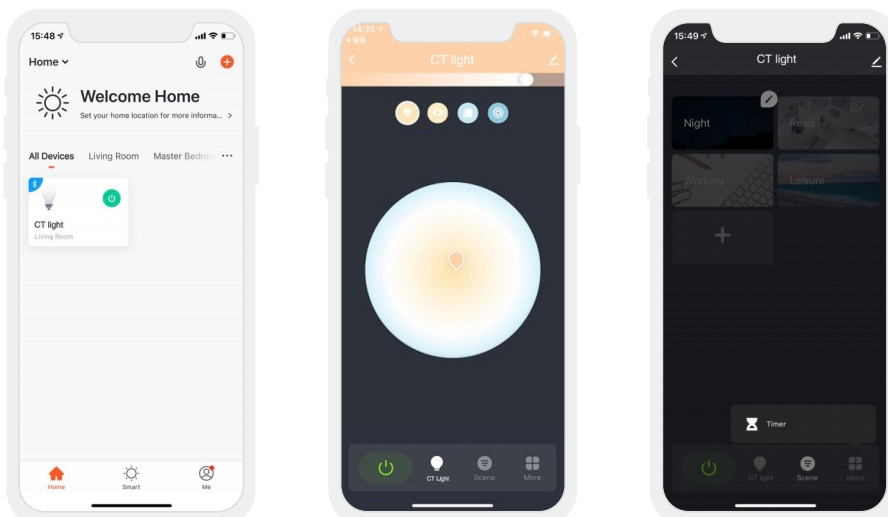

4. Remote control and automation

4.1 Remote control: Follow the prompts to add the Tuya Zigbee Gateway and go to the gateway interface after you added it. Click "Add Subdevice" and add the devices to the gateway ,then you're able to remotely control the devices.

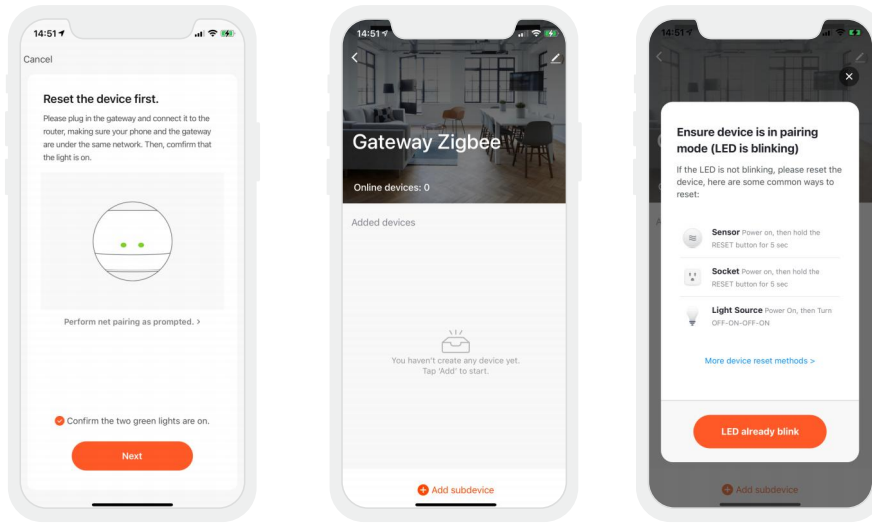

4.2 Automation settings: You can remotely control the light fixtures through "Automation" in "Smart" interface. Set trigger conditions like weather, location, timing and other device status to trigger the predefined lighting effects and achieve the lighting automation.

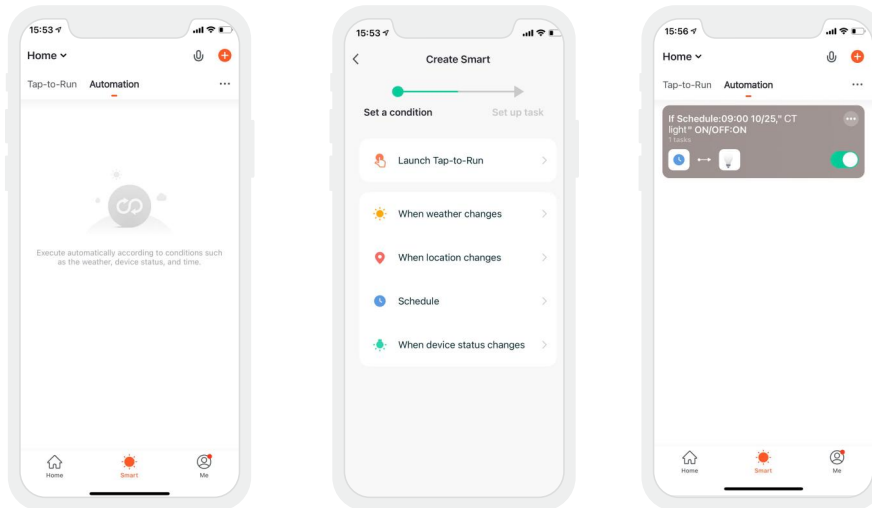

Reset The Device (Reset to factory defaults)

When the driver is power-on, turn it off and after 15s turn it on. After 2s, turn it off again. Repeat the same operation 5 times and then turn on the driver again. When the lamp is flashing [2 flashes/s], reset the device successfully.

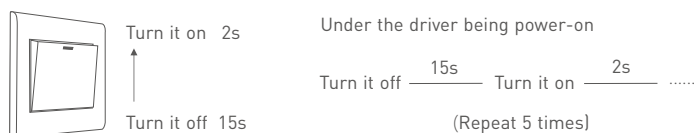

Relationship Diagrams

THD vs Load

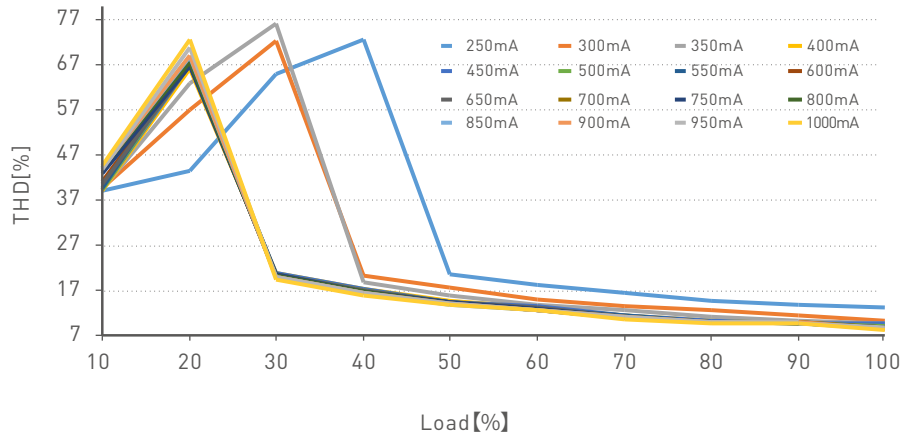

Power Factor Characteristic

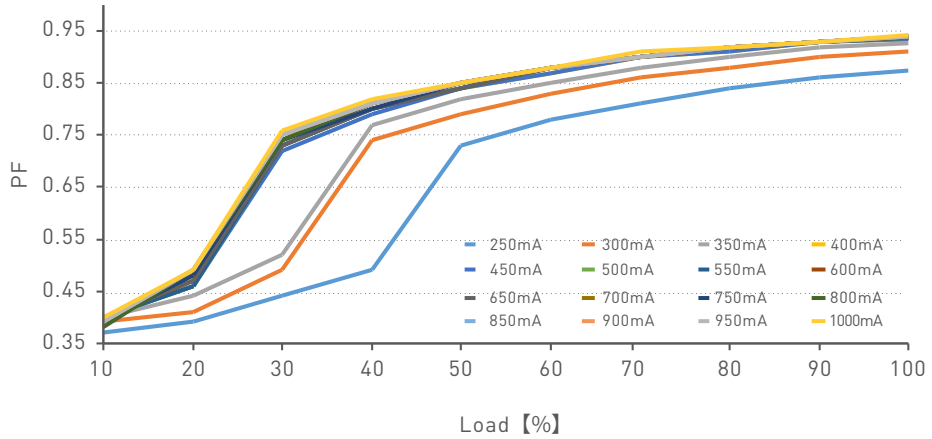

Efficiency vs Load

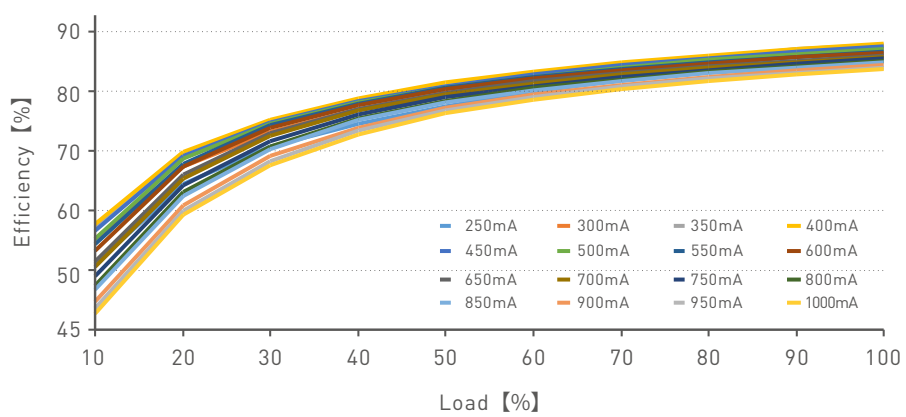

Flicker Test Table

IEEE 1789

Limit Value of Modulation in Low Risk Areas	
Waveform frequency of optical output (f)	Limit value (%)
$f \leq 8\text{Hz}$	0.2
$8\text{Hz} < f \leq 90\text{Hz}$	$0.025 \times f$
$90\text{Hz} < f \leq 1250\text{Hz}$	$0.08 \times f$
$f > 1250\text{Hz}$	Exemption assessment
Limit Value of Modulation in No Effect Areas	
Waveform frequency of optical output (f)	Limit value (%)
$f \leq 10\text{Hz}$	0.1
$10\text{Hz} < f \leq 90\text{Hz}$	$0.01 \times f$
$90\text{Hz} < f \leq 3125\text{Hz}$	$(0.08/2.5) \times f$
$f > 3125\text{Hz}$	Exemption assessment (High frequency exemption)

Brightness

- ▲ 0.1%
- ◆ 1%
- ▲ 5%
- ◆ 10%
- 20%
- ▲ 30%
- 40%
- ★ 50%
- 60%
- 70%
- ★ 80%
- ★ 90%
- ◆ 100%

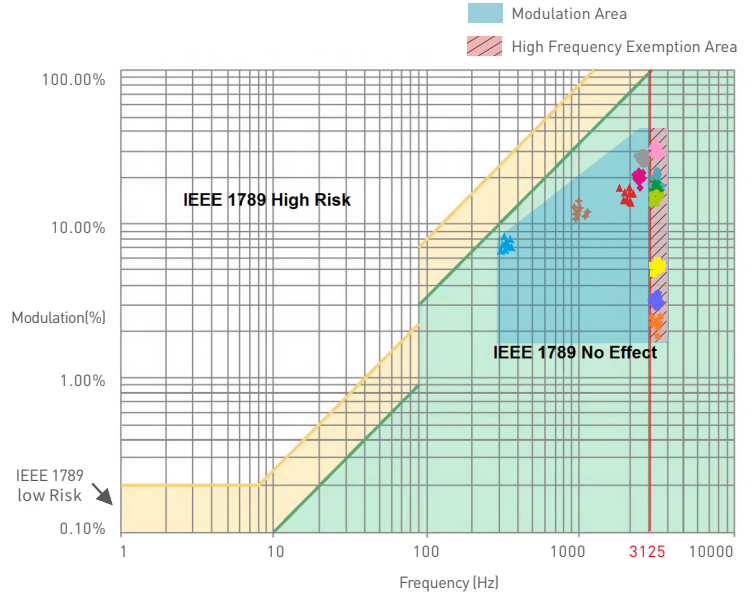

Marks in the right chart are tested results of different current levels
 The output frequency is 0Hz in 100% brightness and its corresponding modulation is 0%, which could not be shown in the right chart.

Packaging Specifications

Model	SE-20-250-1000-W2Z2
Carton Dimensions	370×340×156mm(L×W×H)
Quantity	20 PCS/Layer; 3 Layers/Carton; 60 PCS/Carton
Weight	0.16 kg/PC; 10.4 kg/Carton

Packaging Image



Inner Packaging Box



Carton Packaging

Transportation and Storage

1. Transportation

Products can be shipped via vehicles, boats and planes.

During transportation, products should be protected from rain and sun. Please avoid severe shock and vibration during the loading and unloading process.

2. Storage

The storage conditions should comply with the Class I Environmental Standards. The products that have been stored for more than six months are recommended to be re-inspected and can be used only after they have been qualified.

Attentions

- This product must be installed and adjusted by a qualified professional.
- This product is non-waterproof (special models excepted). Please avoid the sun and rain. When installed outdoors, please ensure it is mounted in a water proof enclosure.
- Good heat dissipation will extend the life the product. Please install the product in a environment with good ventilation.
- When you install this product, please avoid being near a large area of metal objects or stacking them to prevent signal interference.
- Please keep the product away from a intense magnetic field, a high pressure area or a place where lightning is easy to occur.
- Please check whether the working voltage used complies with the parameter requirements of the product.
- Before you power on the product, please make sure all the wiring is correct in case of incorrect connection that may cause a short circuit and damage the components, or trigger a accident.
- If a fault occurs, please do not attempt to fix the product by yourself. If you have any question, please contact the supplier.

* This manual is subject to changes without further notice. Product functions depend on the goods. Please feel free to contact our official distributors if you have any question.

Warranty Agreement

- Warranty periods from the date of delivery: 5 years.
- Free repair or replacement services for quality problems are provided within warranty periods.

Warranty exclusions below:

- Beyond warranty periods.
- Any artificial damage caused by high voltage, overload, or improper operations.
- Products with severe physical damage.
- Damage caused by natural disasters and force majeure.
- Warranty labels and barcodes have been damaged.
- No any contract signed by LTECH.

1. Repair or replacement provided is the only remedy for customers. LTECH is not liable for any incidental or consequential damage unless it is within the law.
2. LTECH has the right to amend or adjust the terms of this warranty, and release in written form shall prevail.

Update Log

Version	Updated Time	Update Content	Updated by
A0	2022.10.08	Original version	Liu Weili