

TD1-4S, TD2-4S, TD3-4S, TD4-4S, TD5-4S



Wall Mounted Touch Panel



TD1-4S
Single color

TD2-4S
Dual color

TD3-4S
RGB

TD4-4S
RGBW

TD5-4S
RGB+CCT

- Touch panel 4 zone 1-5 color DALI master.
- 4 DALI address, support DT6 dimming, DT8-TC color temperature, DT8-RGB or DT8-RGBW.
- DALI-2 certified, in accordance with DALI standard protocol IEC 62386-101, 102, 208 and in compliance with DALI products from other international incorporation.
- Powered by DALI bus or 24VDC.
- Enable to select DALI address by encoding switch, support unicast, group and broadcast mode.
- Match with RF 2.4G four zone remote control optional.
- Ultra sensitive high strength glass touch panel with touch color slide.
- Smooth and accurate color adjustment by touching the color slide.
- 3 scenes memory.
- Touch keys with LED indicator.
- White & Black glass panel available.

Technical Parameters

Input and Output		Dimming data		Safety and EMC	
Power supply	DALI bus/24VDC	Input signal	Touch key + RF 2.4GHz	EMC standard (EMC)	ETSI EN 301 489-1 V2.2.3
Static current	17mA@16VDC, 2mA@24VDC	RF Control distance	10m(Barrier-free space)	EMC standard (EMC)	ETSI EN 301 489-17 V3.2.4
Output signal	DALI	Dimming level	256 levels	Safety standard	EN 62368-1:2020+A11:2020
Environment		Dimming range	0 - 100%	Radio Equipment(RED)	ETSI EN 300 328 V2.2.2
Operation temperature	Ta: -20°C ~ +50°C	Package		Certification	CE, EMC, RED, DALI 2
Case temperature (Max.)	Tc: +65°C	Size	L112 x W112 x H50mm	Warranty	
IP rating	IP20	Gross weight	0.230kg	Warranty	5 years

Mechanical Structures and Installations

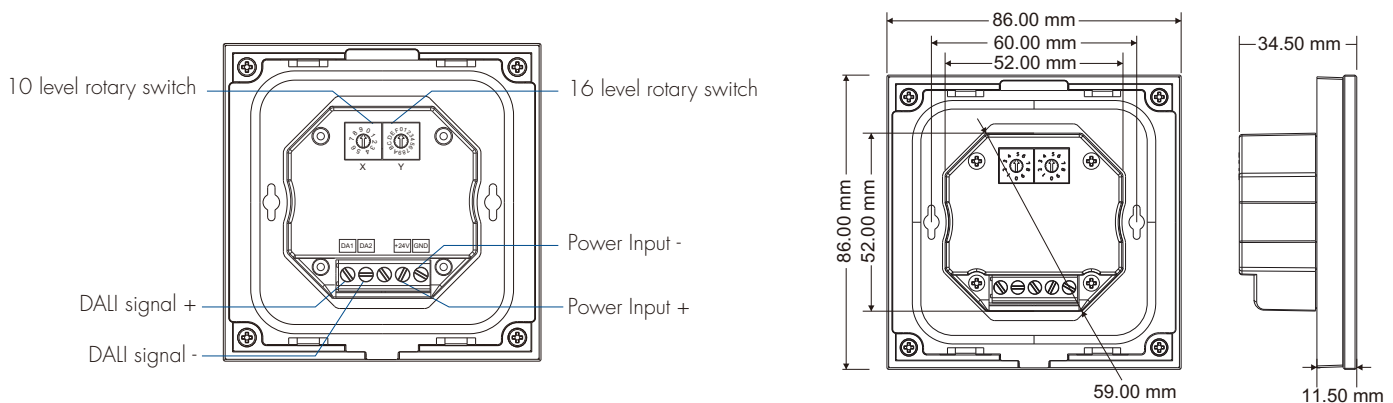

Installation diagram:

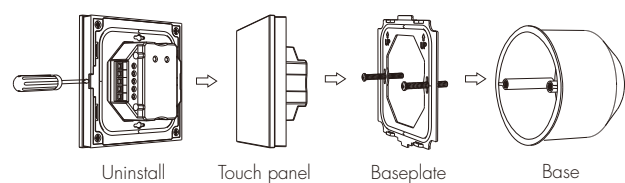

Typical base as below:

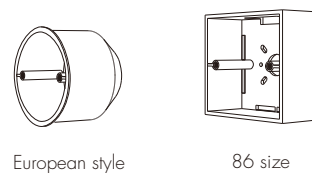

Key function

● TD1-4S 4 zone single color panel

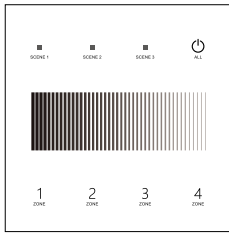

- Turn on/off all zone light.
- Short press recall the scene, long press 5s save current brightness into scene 1/2/3.
- Brightness slide.
- Short press turn on zone light and select zone simultaneously, long press 2s turn off zone light.
- Short press multiple zone key fastly, will select multiple zone synchronously.
- 4 zone control separately or synchronously.

● TD2-4S 4 zone dual color panel

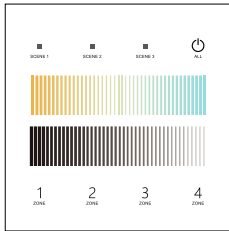

- Turn on/off all zone light.
- Short press recall the scene, long press 5s save current brightness into scene 1/2/3.
- Color temperature slide.
- Brightness slide.
- Short press turn on zone light and select zone simultaneously, long press 2s turn off zone light.
- Short press multiple zone key fastly, will select multiple zone synchronously.
- 4 zone control separately or synchronously.

● TD3-4S 4 zone RGB panel

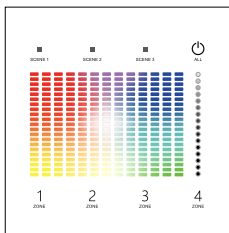

- Turn on/off all zone light.
- Short press recall the scene, long press 5s save current brightness into scene 1/2/3.
- Color slide.
- Brightness slide.
- Short press turn on zone light and select zone simultaneously, long press 2s turn off zone light.
- Short press multiple zone key fastly, will select multiple zone synchronously.
- 4 zone control separately or synchronously.

● TD4-4S 4 zone RGBW panel

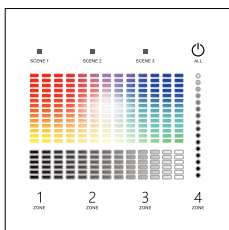

- Turn on/off all zone light.
- Short press recall the scene, long press 5s save current brightness into scene 1/2/3.
- Color slide.
- W channel brightness slide.
- Brightness slide.
- Short press turn on zone light and select zone simultaneously, long press 2s turn off zone light.
- Short press multiple zone key fastly, will select multiple zone synchronously.
- 4 zone control separately or synchronously.

● TD5-4S 4 zone RGB+CCT panel

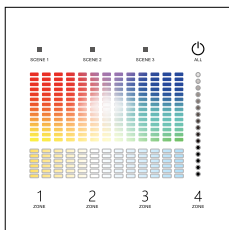

- Turn on/off all zone light.
- Short press recall the scene, long press 5s save current color into scene 1/2/3.
- Color slide.
- Color temperature slide.
- Brightness slide.
- Short press turn on zone light and select zone simultaneously, long press 2s turn off zone light.
- Short press multiple zone key fastly, will select multiple zone synchronously.
- 4 zone control separately or synchronously.

Scene locking:

- Scene keys can be set to locked state, cancel long press for 5 seconds to save the scene function (default scene is not locked).
- Short press the panel on/off key, turn on the light first, then turn off the light, immediately long press the panel on/off key for 5 seconds, then immediately long press any one scene key for 5 seconds to set all scene keys to locked state.
- Short press the panel on/off key, turn on the light first, then turn off the light, immediately long press the panel on/off key for 5 seconds, then immediately long press any one scene key for 10 seconds to restore all scene keys to unlocked state.

Wiring Diagram

1. Powered by DALI bus

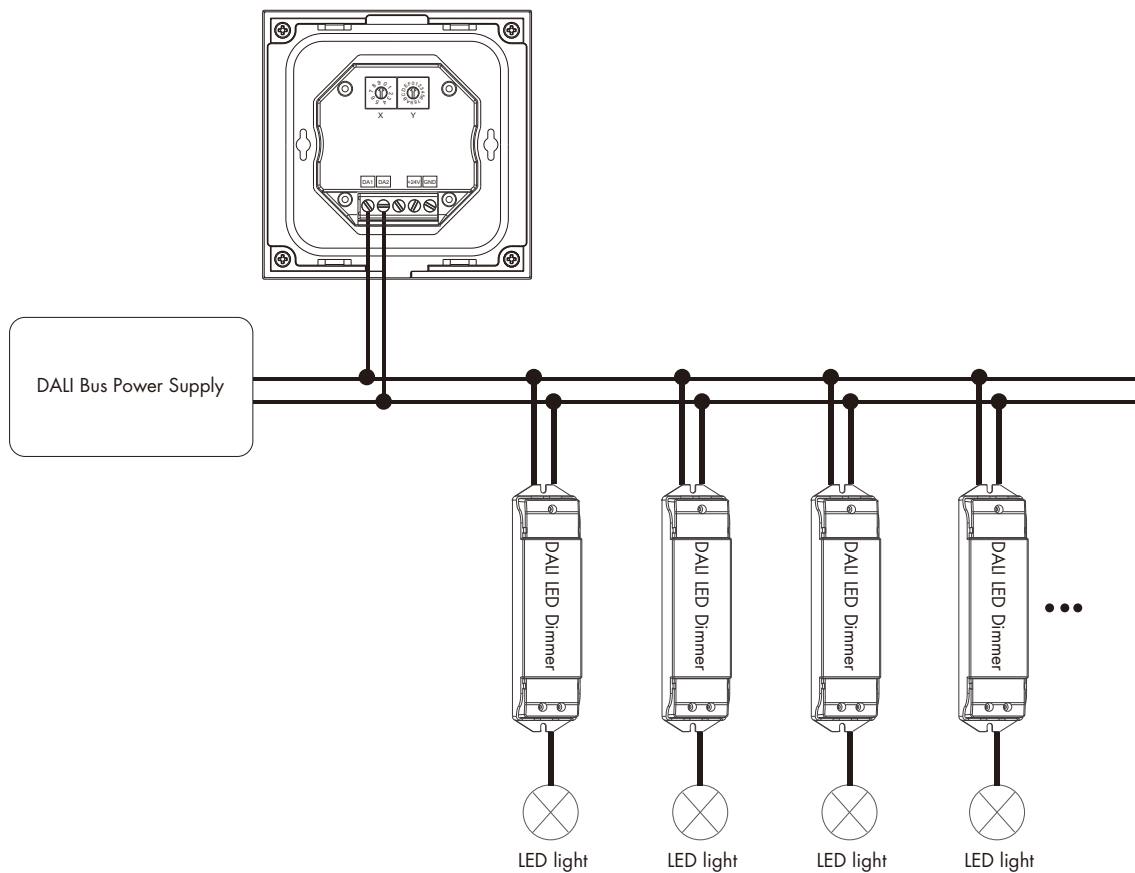

2. Powered by 24VDC

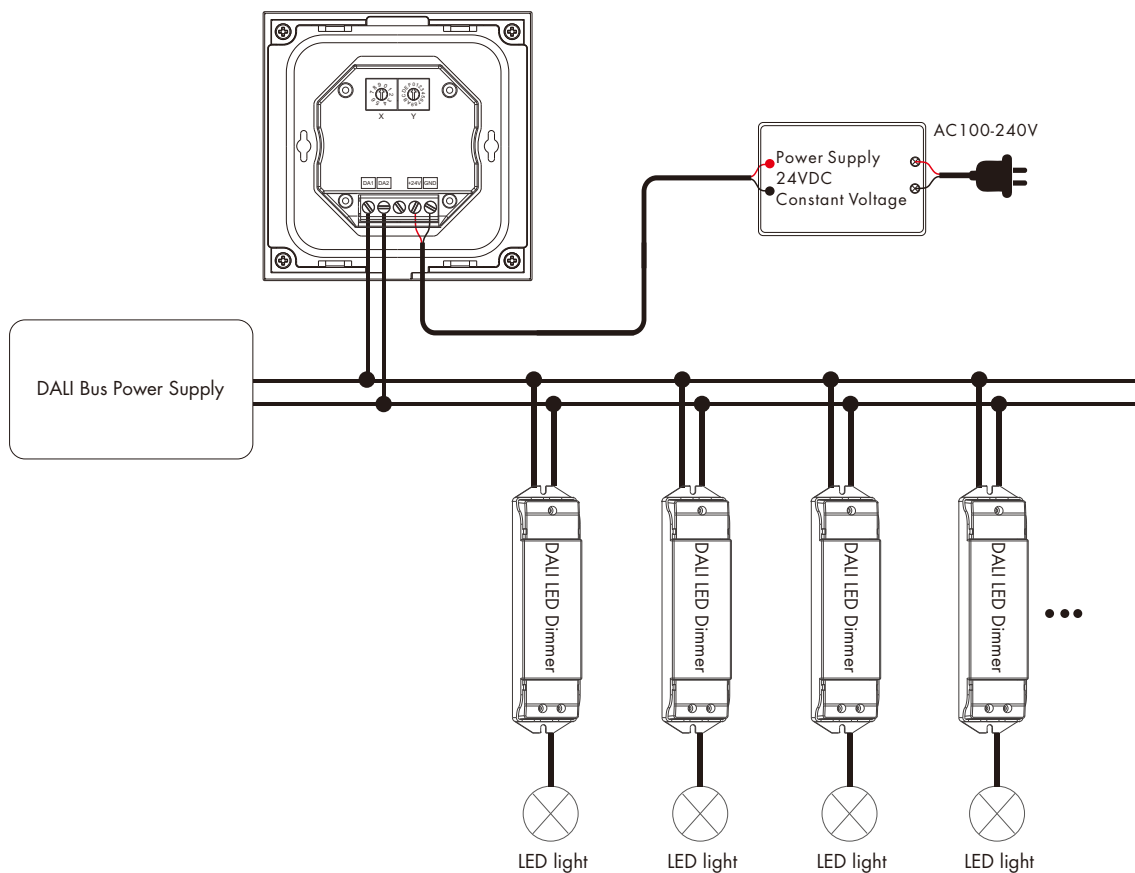

Note: It is recommended to use a 24VDC power supply for the touch panel DALI master to reduce the load on the DALI bus power supply.

Touch Panel DALI master match RF remote

Touch panel DALI master can also match with RF 2.4G four zone remote (Optional).

End user can choose the suitable match/delete ways. Two options are offered for selection:

Use On/Off key

Match:

Turn on light, turn off, immediately press the On/Off key of the panel for 5s, then press any zone key of the RF remote within 5s.

The LED indicator fast flash 3 times means match is successful.

Delete:

Turn on light, turn off, immediately press the On/Off key of the panel for 10s to delete all match,

The LED indicator fast flash 6 times means all matched remotes were deleted.

Use Power Restart

Match:

Switch off the power of the panel, then switch on power, repeat again.

Immediately short press zone key 3 times on the remote.

The LED indicator fast flash 3 times means match is successful.

Delete:

Switch off the power of the panel, then switch on power, repeat again.

Immediately short press zone key 5 times on the remote.

The LED indicator fast flash 6 times means all matched remotes were deleted.

DALI address setting

Address value = $X * 10 + Y$.

For example: $X = 5, Y = 4$, Address value = $5 * 10 + 4 = 54$.

Unicast mode

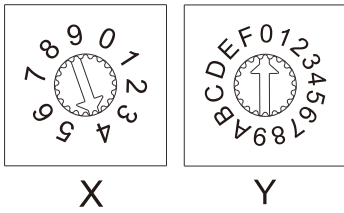

X is 0-6, Y is 0-9.

Address value 0-63 correspond to DALI unicast address 00-63.

For example:

Address value = 40, the unicast values of zone 1,2,3,4 are 40, 41, 42, 43.

Address value = 62, the unicast values of zone 1,2,3,4 are 62, 63, 0, 1.

Group mode

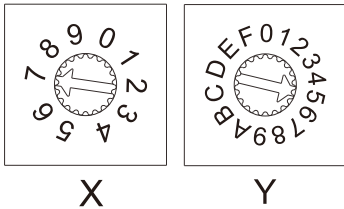

X is 7, Y is 0-F.

Address value 70-7F correspond to DALI group address 0-15.

For example:

Address value = 75, the group address value of zone 1,2,3,4 are 5, 6, 7, 8.

Address value = 7E, the group address value of zone 1,2,3,4 are 14, 15, 0, 1.

Broadcast mode

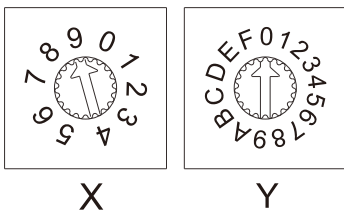

X is 9, Y is 0-F.

Address value 90 - 9F correspond to broadcast address.