

Wall Mounted Touch DALI Panel

Model No.: TS4-D

4 button / Proximity sensing / Glass touch panel / Encoding switch select addresses

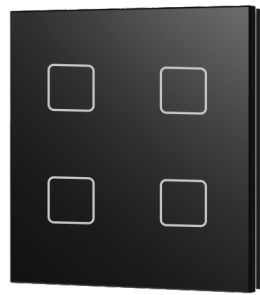
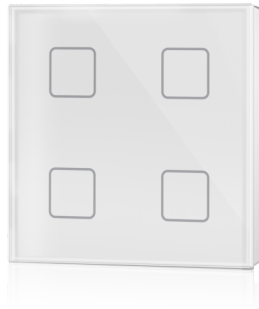

CE RoHS

Features

- 4-button touch panel DALI master, control 4 DALI Addresses.
- Comply to latest DALI standard protocol IEC62386 and in compliance with DALI products from other international incorporation.
- Powered by DALI bus or 24VDC.
- Enable to select 4 different addresses for controlling by encoding switch.
- Support scene, group, unicast and broadcast mode.
- Ultra sensitive high strength glass touch panel.
- Each button with blue LED indicator.
- Automatic blue backlight with proximity sensing to human fingers/palms.
- White & Black glass panel available.

Technical Parameters

| Input and Output | | Environment | | Package | |
|------------------|-----------------------|-------------------------|-------------------|-----------------|--------------------|
| Power input | DALI bus/24VDC | Operation temperature | Ta: -20°C ~ +50°C | Size | L112x W112 x H50mm |
| Static current | 15mA@16VDC, 2mA@24VDC | Case temperature (Max.) | Ta: +55°C | Gross weight | 0.223kg |
| Input signal | Touch key | IP rating | IP20 | Warranty | |
| Sensing distance | ≤5cm | | | Warranty | 5 years |

Mechanical Structures and Installations

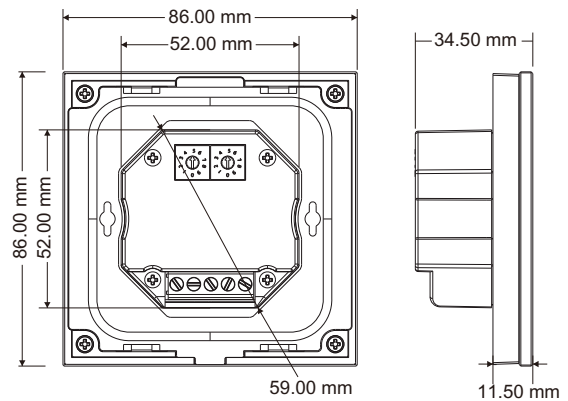
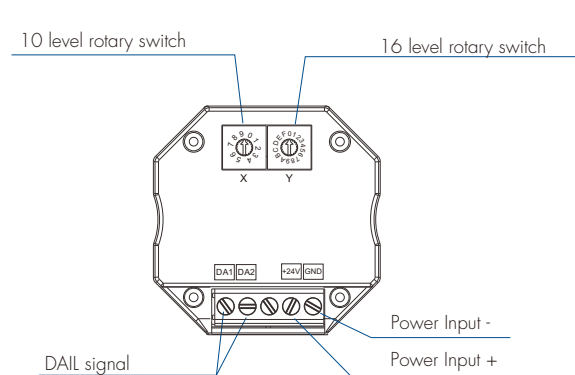

Installation diagram:

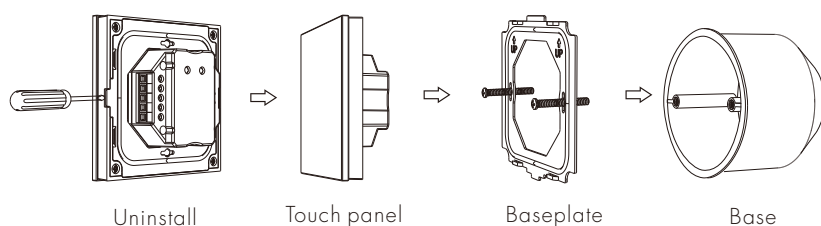

Typical base as below:

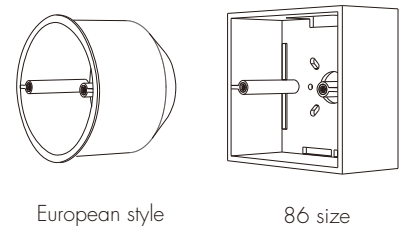

Wiring Diagram

1. Powered by DALI bus

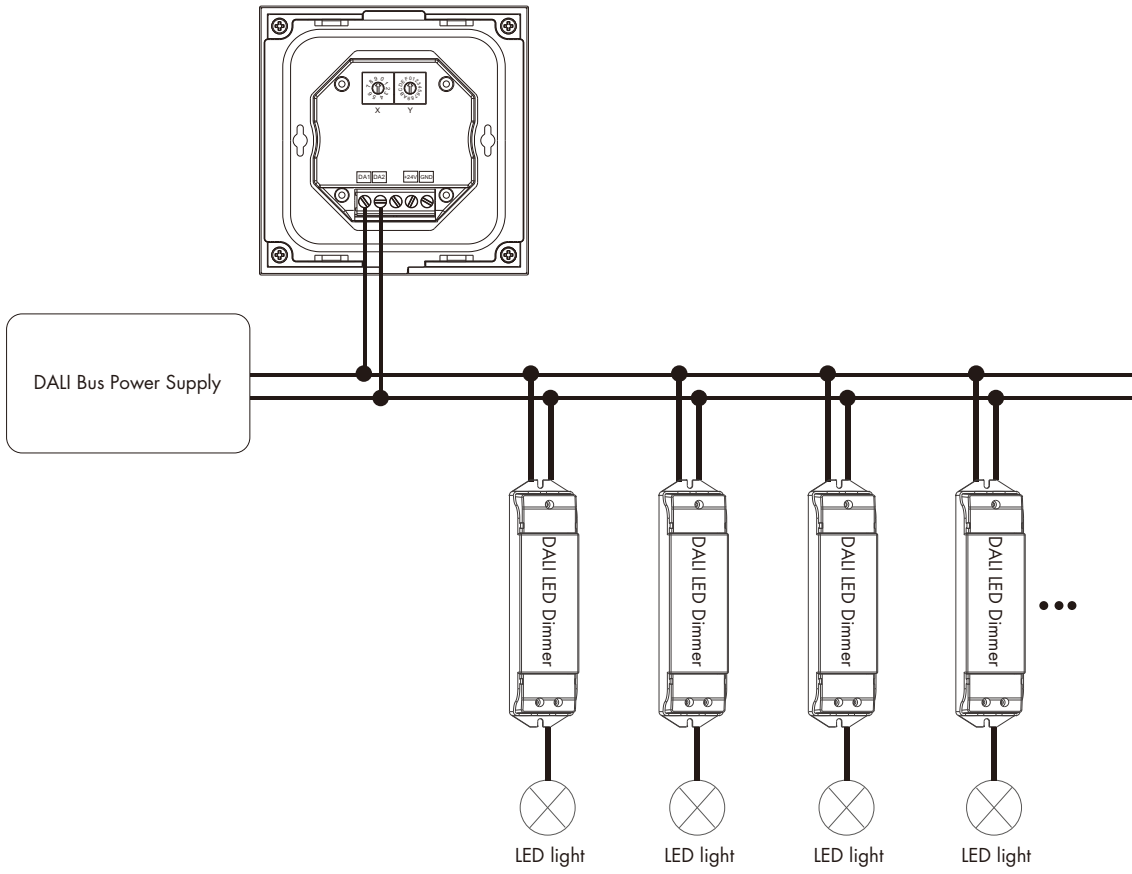

2. Powered by 24VDC

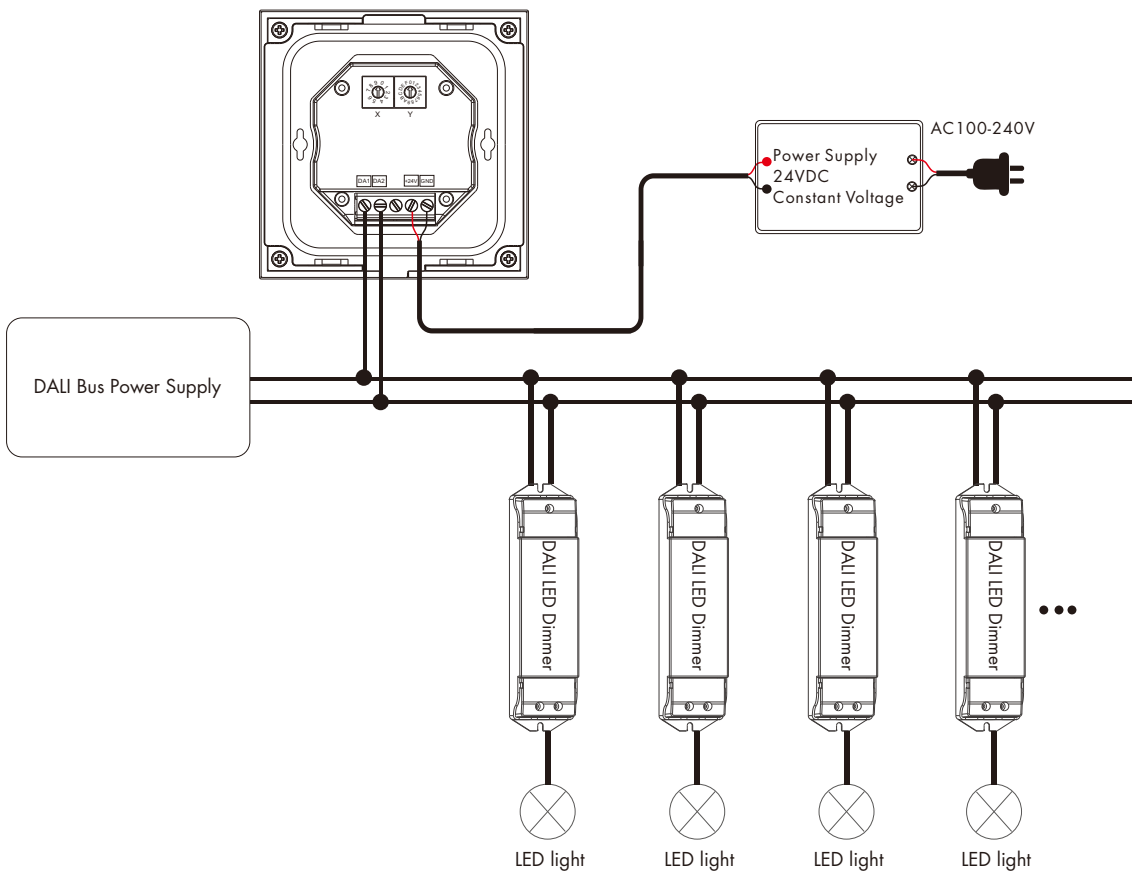

Note: It is recommended to use a 24VDC power supply for the touch panel DALI master to reduce the load on the DALI bus power supply.

Button function

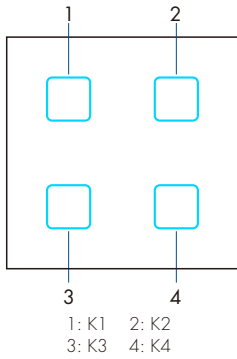

Proximity sensing:

The panel backlight will be turned on when human fingers or palms are being closed to glass panel at < 5 cm, and the light will be brighter when buttons are being pressed.

Long press on any two buttons simultaneously >10 seconds will activate (blinking 10 times) or deactivate (blinking 5 times) the proximity sensing function.

Sound feedback:

Buzzing sound feedback will be played when buttons being touched.

Long press on any two buttons simultaneously >5 seconds will activate (blinking 4 times) or deactivate (blinking 2 times) the sound feedback function.

Installation note:

When it is necessary to activate the proximity sensing function, the touch panel cannot be surrounded by other metal objects within 10cm, otherwise it will be easy to appear false triggering phenomenon.

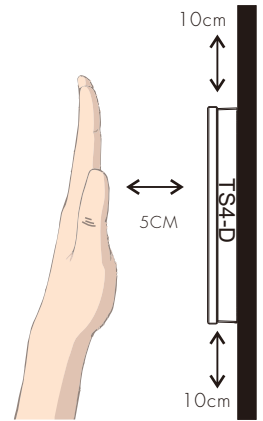

DALI address setting

Address value = X * 10 + Y.

For example: X = 5, Y = 4, Address value = 5 x 10 + 4 = 54.

Unicast mode

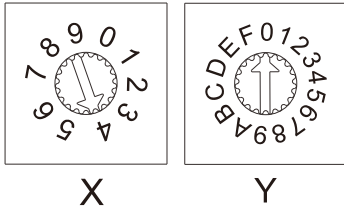

X is 0-6, Y is 0-9.

Address value 0-63 correspond to DALI unicast address 00-63.

For example:

Address value = 40, the unicast values of K1, K2, K3, K4 button are 40, 41, 42, 43.

Address value = 62, the unicast values of K1, K2, K3, K4 button are 62, 63, 0, 1.

Short press K1, K2, K3, K4 to turn on/off light.

Long press K1, K2, K3, K4 to increase or decrease brightness.

Group mode

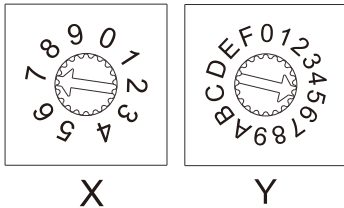

X is 7, Y is 0-F.

Address value 70-7F correspond to DALI group address 0-15.

For example:

Address value = 5, the group address value of K1, K2, K3, K4 button are 5, 6, 7, 8.

Address value = E, the group address value of K1, K2, K3, K4 button are 14, 15, 0, 1.

Short press K1, K2, K3, K4 to turn on/off light.

Long press K1, K2, K3, K4 to increase or decrease brightness.

Scene mode

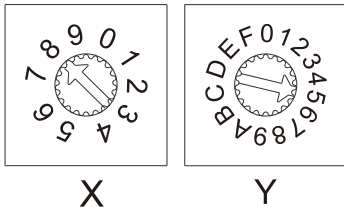

X is 8, Y is 0-F.

Address value 80-8F correspond to DALI scene 0-15.

For example:

Address value = 5, the scene value of K1, K2, K3, K4 button are 5, 6, 7, 8.

Address value = E, the scene value of K1, K2, K3, K4 button are 14, 15, 0, 1.

Short press K1, K2, K3, K4 to recall the scene.

Long press K1, K2, K3, K4 (2s) to turn off the scene light.

Broadcast mode

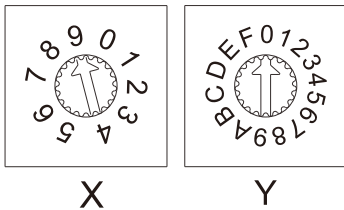

X is 9, Y is 0-F.

Address value 90 - 9F correspond to broadcast address.

Short press K1, K2, K3, K4 to turn on/off light,

long press K1, K2, K3, K4 to increase or decrease brightness.