

4 Channel Constant Voltage LED Waterproof RF Controller

Model No.: V4-WPS

IP67 waterproof/4 Channels/Step-less dimming/Wireless remote control/Auto-transmitting/Synchronize

Features

- Waterproof 4 channel constant voltage LED RF controller with IP67 rating, suitable for outdoor and damp environment.
- Match with RF 2.4G single zone or multiple zone single color, dual color and RGB/RGBW remote control.
- One RF controller accept up to 10 remote control.
- 4096 levels 0-100% dimming smoothly without any flash.
- When using with RGB/RGBW light, built in 10 dynamic mode, include jump or gradual change style.
- Auto-transmitting function: Controller automatically transmit signal to another controller with 30m control distance.
- Synchronize on multiple number of controllers.
- Fade in and out effect selectable.

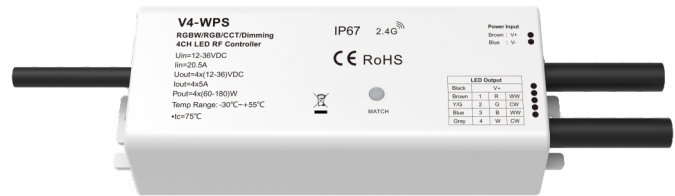

FC CE RoHS emc LVD RED

Technical Parameters

Input and Output		Dimming data		Safety and EMC	
Input voltage	12-36VDC	Input signal	RF 2.4GHz	EMC standard (EMC)	ETSI EN 301 489-1 V2.2.3 ETSI EN 301 489-17 V3.2.4
Input current	20.5A	Control distance	30m(Barrier-free space)	Safety standard(LVD)	EN 62368-1:2020+A11:2020
Output voltage	4 x (12-36)VDC	Dimming gray scale	4096 (2^12) levels	Radio Equipment(RED)	ETSI EN 300 328 V2.2.2
Output current	4CH,5A/CH	Dimming range	0 -100%	Certification	CE,EMC,IVD,RED
Output power	4x(60-180W)	Dimming curve	Logarithmic	Environment	
Output type	Constant voltage	PWM frequency	1000Hz (default)	Operation temperature	T _a : -30°C ~ +55°C
Warranty		Package		Case temperature (Max.)	T _c : +85°C
Warranty	5 years	Size	L165 x W98 x H72mm	IP rating	IP67
		Gross weight	0.492kg		

Mechanical Structures and Installations

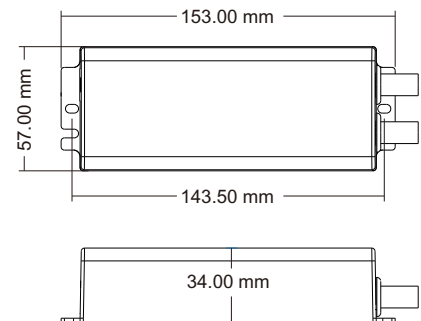
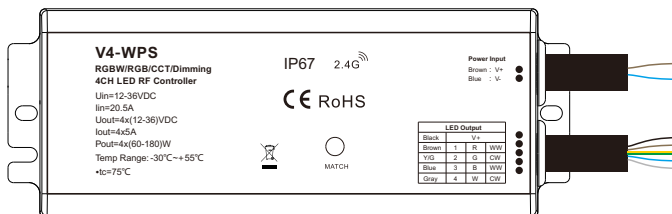

Wiring Diagram

- V4-WPS for RGB/RGBW

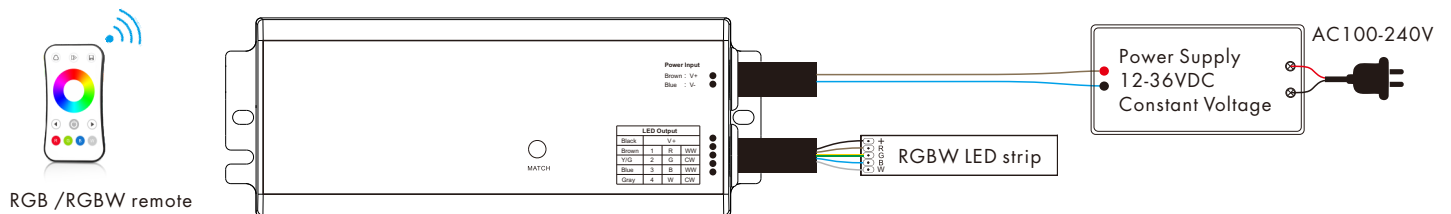

Note: If connect with RGB LED strip, please long press match key for 1.5s, the controller will become RGB type, the light blinks 5 times.

- V4-WPS for dual color

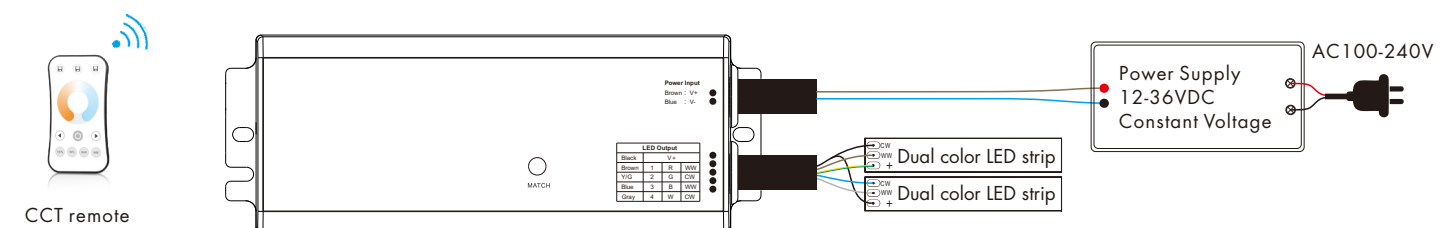

• V4-WPS for single color

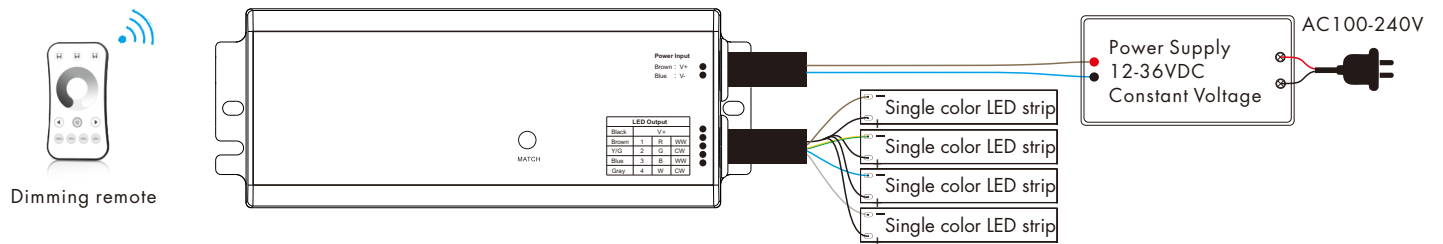

Match Remote Control (two match ways)

End user can choose the suitable match/delete ways. Two options are offered for selection:

Use the controller's Match key

Match:

Short press match key, immediately press on/off key (single zone remote) or zone key (multiple zone remote) of the remote.

Delete:

Press and hold match key for 5s to delete all match, The light blinks 3 times means all matched remotes were deleted.

Use Power Restart

Match:

Switch off the power, then switch on power, repeat again. Immediately short press on/off key (single zone remote) or zone key (multiple zone remote) 3 times on the remote. The light blinks 3 times means match is successful.

Delete:

Switch off the power, then switch on power, repeat again. Immediately short press on/off key (single zone remote) or zone key (multiple zone remote) 5 times on the remote. The light blinks 5 times means all matched remotes were deleted.

RGB/RGBW dynamic mode list

No.	Name	No.	Name
1	RGB jump	6	RGB fade in and out
2	RGB smooth	7	Red fade in and out
3	6 color jump	8	Green fade in and out
4	6 color smooth	9	Blue fade in and out
5	Yellow cyan purple smooth	10	White fade in and out

Fade in and Fade out Setting

Long press match key 5s, then short press match key 3 times, the lighting effect will be set to the fade in and fade out in 3s. Long press match key 10s, restore factory default parameter, the light blinks 10 times, the light on/off time restores to 0.5s.

Dual color control

CH1,CH3=Warm white LED CH2,CH4=Cool white LED

Each channel can supply up to 120W(@24V) and white balance can be controlled as such:

Color temperature	Cool white	Neutral white	Warm white
Power distribution	CH1=0W,CH2=120W CH3=0W,CH4=120W	CH1=60W,CH2=60W CH3=60W,CH4=60W	CH1=120W,CH2=0W CH3=120W,CH4=0W

Linear dual color tuning

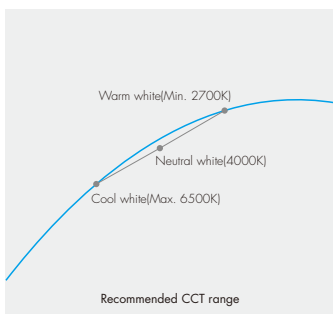

Dimming curve for CCT

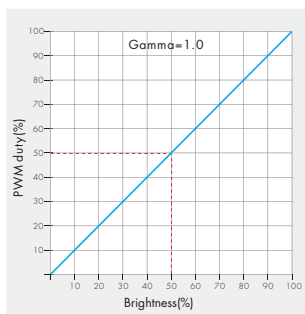

Dimming curve for RGBW/RGB/DIM

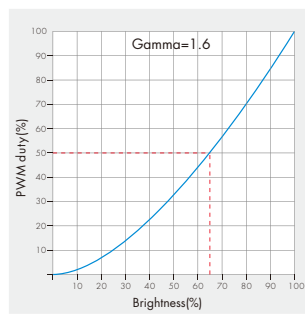

Malfunctions analysis & troubleshooting

Malfunctions	Causes	Troubleshooting
No light	1. No power. 2. Wrong connection or insecure.	1. Check the power. 2. Check the connection.
Wrong color	1. Wrong connection of R/G/B/W wires.	1. Reconnect R/G/B/W wires.
Uneven intensity between front and rear, with voltage drop	1. Output cable is too long. 2. Wire diameter is too small. 3. Overload beyond power supply capability. 4. Overload beyond controller capability.	1. Reduce cable or loop supply. 2. Change wider wire. 3. Replace higher power supply. 4. Add power repeater.
No response from the remote	1. The battery has no power. 2. Beyond controllable distance. 3. The controller did not match the remote.	1. Replace battery. 2. Reduce remote distance. 3. Re-match the remote.