

Bluetooth & RF 5 in 1 LED Controller

Model No.: V5-L(WB)

Tuya APP cloud control/5 Channels/1-5 color/DC12-48V/Four PWM frequency/Wireless remote control/Push Dim



RoHS CE LVD RED

Features

- 5 in 1 function, used for control RGB, RGBW, RGB+CCT, color temperature or single color LED strip.
- DC12-48V input, 5 channel constant voltage output.
- Tuya APP cloud control, support on/off, RGB color, color temperature and brightness adjust, delay turn on/off light, timer run, scene edit and music play function.
- Voice control, support amazon ECHO and TmallGenie smart speaker.
- Match with RF 2.4G remote control optional.
- User need set light type by press key before Tuya APP network connection and match RF remote of the same light type.
- Each V5-L(WB) controller can also work as Bluetooth+RF converter, then use Tuya APP to control one or more RF LED controller or RF LED dimming driver synchronously.
- PWM frequency 500Hz, 2000Hz, 8000Hz or 16000Hz selectable.
- Light on/off fade time 3s selectable.
- Connect with external push switch to achieve on/off and 0-100% dimming function.

Technical Parameters

Input and Output	
Input voltage	12-48VDC
Input current	30.5A
Output voltage	5 x (12-48)VDC
Output current	6A/CH @ 12/24V 4A/CH @ 36/48V
Output type	Constant voltage
Dimming data	
Input signal	Tuya APP + RF 2.4GHz + Push-DIM
Control distance	30m(Barrier-free space)
Dimming gray scale	4096 [2^12] levels
Dimming range	0-100%
Dimming curve	Logarithmic
PWM Frequency	2000Hz [default]

Safety and EMC	
EMC standard [EMC]	ETSI EN 301 489-1 V2.2.3 ETSI EN 301 489-17 V3.2.4
Safety standard[LVD]	EN 62368-1:2020+A11:2020
Radio Equipment[RED]	ETSI EN 300 328 V2.2.2
Certification	CE,EMC,LVD,RED
Environment	
Operation temperature	Ta: -30°C ~ +55°C
Case temperature (Max.)	Tc: +85°C
IP rating	IP20
Warranty and Protection	
Warranty	5 years
Protection	Reverse polarity Over-heat Short circuit

Mechanical Structures and Installations

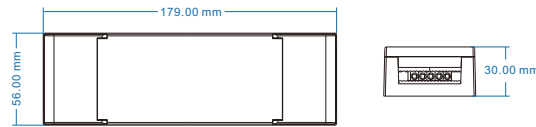
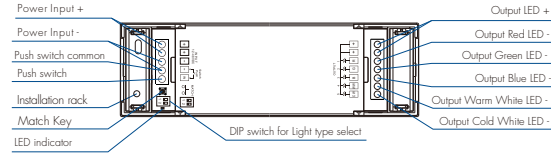

System wiring

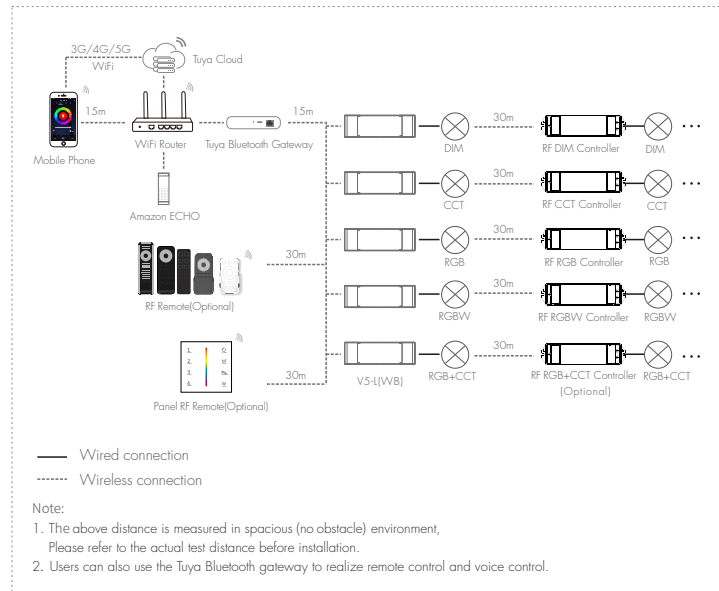

Wiring Diagram

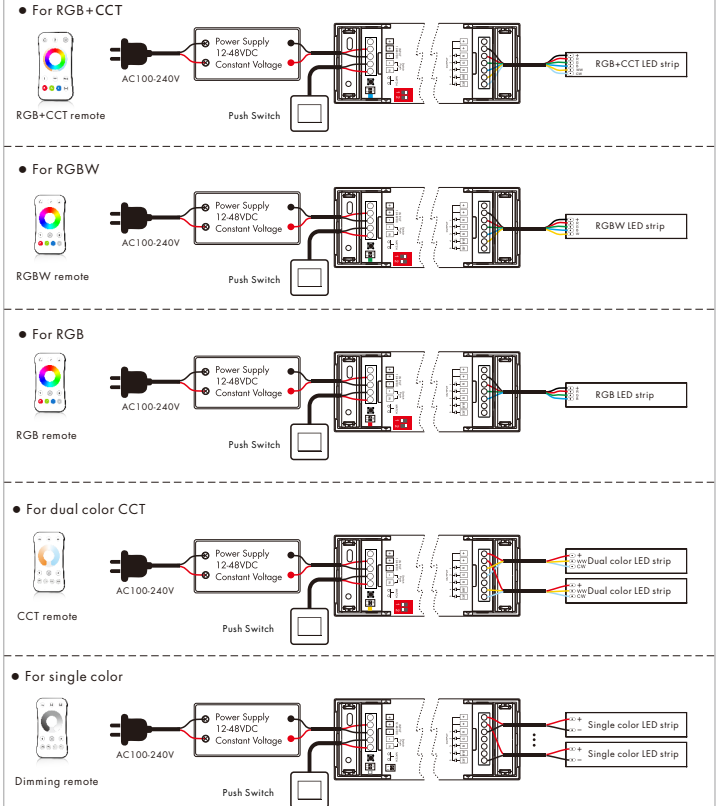

Press and hold MATCH key for 1.5s, until the RUN LED indicator turn white, then release, the controller will become DIM type, the light on/off time also restore to 0.5s, the PWM frequency also restore to 2000Hz.

- Note:
1. After changed the light type by DIP switch, please redo the tuya APP config operation.
 2. For RGB+CCT or CCT light type, continuous power on and off will change 3 levels color temperature (WW, NW and CW) in sequence.
 3. Switch off the power, then switch on power, repeat again.
 Immediately short press match key 3 times, the light on/off time will change between 3s and 0.5s.

Tuya APP network connection

Press and hold Match key for 5s, or push twice Match key fastly:
Clear previous network connection, enter config mode, the purple LED indicator fast flash, the output LED will flash 10 times.

Repeat power on and off for 5 consecutive times, also clear previous network connection, enter config mode, the output LED will flash 10 times.

If Tuya APP network connection succeed, the RUN LED indicator will stop flash purple, and turn corresponding light type color (White: DIM, Yellow: CCT, Red: RGB, Green: RGBW, Blue: RGB+CCCT), and in Tuya APP, you can find BT-RGB+CCCT device (or other DIM, CCT, RGB or RGBW).

Tuya APP interface

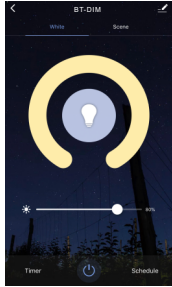

White interface

For DIM type:
Touch brightness slide to adjust brightness.

For RGB type:
Touch brightness slide, get RGB mixed white firstly, then to adjust white brightness.

For RGBW type:
Touch brightness slide, adjust white channel brightness.

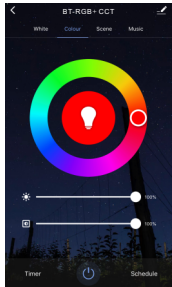

Colour interface

For RGB or RGBW type:
Touch color wheel to adjust static RGB color.
Touch brightness slide to adjust color brightness.
Touch saturation slide to adjust color saturation, namely gradient from the current color to white [RGB mixed].

For RGB+CCCT type:
Touch color wheel to adjust static RGB color, WWW/CW will turn off automatically.
Touch brightness slide to adjust color brightness.
Touch saturation slide to adjust color saturation, namely gradient from the current color to white [RGB mixed].

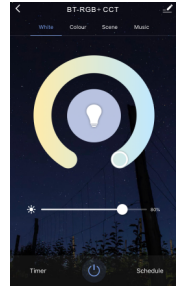

Color temperature interface

For CCT type:
Touch color wheel to adjust color temperature.
Touch brightness slide to adjust brightness.

For RGB+CCCT type:
Touch color wheel to adjust color temperature, RGB will turn off automatically.
Touch brightness slide to adjust white brightness.

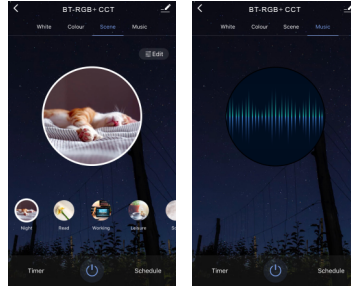

Scene interface

- The 1-4 scene is static color for all light type. the inner color of these scene can be editable.
- The 5-8 scene is dynamic mode for RGB, RGBW, RGB+CCCT type, such as green fade in and fade out, RGB jump, 6 color jump, 6 color smooth.

Music, Timer, Schedule

- The music play can use smart phone music player or microphone as music signal input.
- The Timer key can turn on or turn off light in the next 24 hours.
- The Schedule key can add multiple timers to turn on or turn off light according to different time periods.

V5-L(WB) match remote control (Optional)

End user can choose the suitable match/delete ways. Two options are offered for selection:

Use the controller's Match key

Match:
Short press match key of V5-L(WB), immediately press on/off key (single zone remote) or zone key (multiple zone remote) on the remote. The LED indicator fast flash a few times means match is successful.

Delete:
Press and hold match key of V5-L(WB) for 10s, The LED indicator fast flash a few times means all matched remotes were deleted.

Use Power Restart

Match:
Switch off the power of V5-L(WB), then switch on power, repeat again. Immediately short press on/off key (single zone remote) or zone key (multiple zone remote) 3 times on the remote. The light blinks 3 times means match is successful.

Delete:
Switch off the power of V5-L(WB), then switch on power, repeat again. Immediately short press on/off key (single zone remote) or zone key (multiple zone remote) 5 times on the remote. The light blinks 5 times means all matched remotes were deleted.

V5-L(WB) work as Bluetooth-RF converter to match RF LED controller or dimming driver

End user can choose the suitable match/delete ways. Two options are offered for selection:

Use the controller's Match key

Match:
Short press match key of the controller, immediately press on/off key on the Tuya APP. The LED indicator fast flash a few times means match is successful.

Delete:
Press and hold match key of the controller for 5s, The LED indicator fast flash a few times means match was deleted.

Use Power Restart

Match:
Switch off the power of the controller, then switch on power, repeat again. Immediately short press on/off key 3 times on the Tuya APP. The light blinks 3 times means match is successful.

Delete:
Switch off the power of the controller, then switch on power, repeat again. Immediately short press on/off key 5 times on the Tuya APP. The light blinks 5 times means match was deleted.

PWM frequency setting



When power is off, select the DIP switch firstly, then press hold the MATCH key, and power up the controller in the same time, the RUN LED indicator will flash white color two times means PWM frequency setting is successful.
We can select four PWM frequency: 500Hz, 2000Hz, 8000Hz or 16000Hz.
Higher PWM frequency, will cause lower output current, higher power noise, but more suitable for camera (No flickers for video).

Push Dim

Light Type	Action	Effect
Single color	Click	ON/OFF
	Double Click	Turn on at 100% or 10% (night light) and vice-versa
	Long press(>1 s) from OFF	Dimming UP/DOWN
	Long press(>1 s) from ON	Dimming UP/DOWN
Dual Color	Click	ON/OFF
	Double Click	Turn on at 100% or 10% (night light) and vice-versa
	Long press(>1 s) from OFF	Color temperature UP/DOWN (turn off and turn on to return dimming)
	Long press(>1 s) from ON	Dimming UP/DOWN
RGB	Click	ON/OFF
	Double Click	Change from color mode to white mode (RGB mixed) and vice-versa
	Long press(>1 s) from OFF	If on color mode change rotation speed; If on white mode dimming UP/DOWN
	Long press(>1 s) from ON	If on color mode start/stop color rotation; If on white mode dimming UP/DOWN
RGBW	Click	ON/OFF
	Double Click	Change between color mode, white mode (W channel) and color+W mode
	Long press(>1 s) from OFF	If on color mode change rotation speed; If on white mode or color+W mode, W dimming UP/DOWN
	Long press(>1 s) from ON	If on color mode start/stop color rotation; If on white mode or color+W mode, W dimming UP/DOWN
RGB+CCCT	Click	ON/OFF
	Double Click	Change from color mode to tunable white mode and vice-versa
	Long press(>1 s) from OFF	If on color mode change rotation speed; If on tunable white mode color temperature UP/DOWN (turn off and turn on to return dimming)
	Long press(>1 s) from ON	If on color mode start/stop color rotation; If on tunable white mode dimming UP/DOWN



Color rotation:

We can select 4 rotation speed:
10 flash/s means 6 seconds color rotation
5 flash/s means 30 seconds color rotation
2 flash/s means 1 minute color rotation
1 flash/s means 6 minutes color rotation

Dynamic mode list

For RGB/RGBW:

No.	Name	No.	Name
1	RGB jump	6	RGB fade in and out
2	RGB smooth	7	Red fade in and out
3	6 color jump	8	Green fade in and out
4	6 color smooth	9	Blue fade in and out
5	Yellow cyan purple smooth	10	White fade in and out

For RGB+CCCT:

No.	Name	No.	Name
1	RGB jump	6	RGB fade in and out
2	RGB smooth	7	Red fade in and out
3	6 color jump	8	Green fade in and out
4	6 color smooth	9	Blue fade in and out
5	Color temperature smooth	10	White fade in and out