

Manual Instruction

Please read the instructions carefully before using the controller.

1. Features

The controller is adopted by the most advanced PWM control technology, and has memory function (The light status will keep same as the status before you turn off the light); Wireless and 4G controlled by Tuya Smart Life APP.

- 16 Millions of colors to choose
- Color temperature 2700K~6500K
- Dim brightness / saturation
- Support music rhythm
- Support scene customization
- Timing setting / countdown turn on / off LED light
- Bluetooth wireless control
- Tap-to-Run & automation
- Free screw when connecting to LED strip
- WiFi wireless control
- Smartphone APP control
- Support third party voice control
- Support remote control (control distance 30m)
- Device sharing
- Group control
- 2.4G wireless transmission technology
- Auto-transmitting & Synchronization
- Link/Unlink/Reset Button on the controller

WiFi&BT 5-in-1 LED Strip Controller

Model No.: WB5

4. Auto-transmitting Diagram

One strip controller can transmit the signals from the remote control to another controller within 30m, as long as there is a strip controller within 30m, the remote control distance can be limitless.

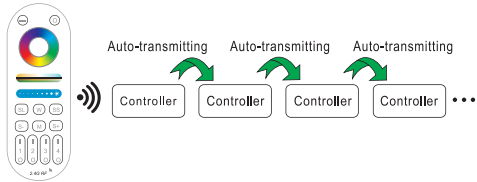

5. Connect to LED strip

Controller input voltage must be in accordance with the required voltage of LED Strips.
Input voltage=Output Voltage

Connect to Single Color LED strip diagram



Connect to CCT LED strip diagram

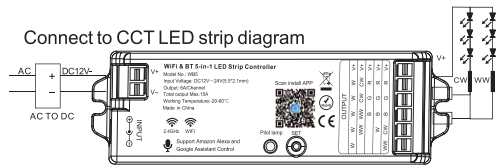

Connect to RGB LED strip diagram

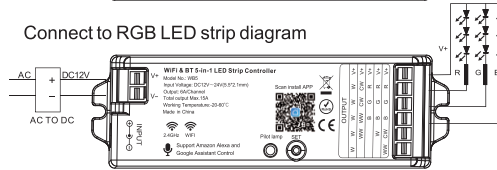

Connect to RGBW LED strip diagram

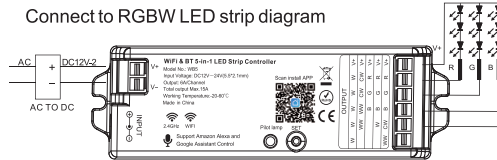

Connect to RGB+CCT LED strip diagram

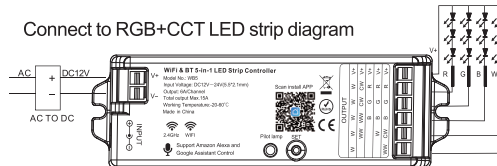

2. Parameters

Model No.: WB5
 Input Voltage: DC12V~24V (5. 5*2. 1mm)
 Output: 6A/Channel (Total Output Max. 15A)
 Working Temperature: -20~60°C
 Communication Mode: WiFi-IEEE 802. 11b/g/n 2. 4GHz
 RF: 2. 4GHz Weight: 65g



Smart Link&Unlink: We have 3 methods to Link and Unlink to APP.

1. Long press "SET" 3 seconds, the purple light will blink 3 times, the device goes into Smart Link/Unlink mode.
2. Use Linked 091 remote, long press the linked Zone ON button for 3 seconds, the purple light will blink 3 times, the device goes into Smart Link and Unlink Mode.
3. Switch ON and OFF 3 times (ON-OFF-ON-OFF-ON) within 10 seconds, the purple light will blink 3 times, the device goes into Smart Link and Unlink Mode.

Note: Pilot lamp red light always ON means device not link to APP, need to do above steps to link. green light always ON means device linked to APP; device is controllable.

Switching Output Mode: Short press "SET" button to switch the output mode; The indicating lamp flickering means switching successfully; Different colors flickering correspond to different output mode; Details see below sheet.

White Light Flickering	Yellow Light Flickering	Red Light Flickering	Green Light Flickering	Blue Light Flickering
Single Color Mode	Dual White Mode	RGB Mode	RGBW Mode	RGB+CCT Mode (Default Mode)

6. Remote Controller

Compatible with these remote controls (Purchased separately).
 For more details, pls read the remote instruction.

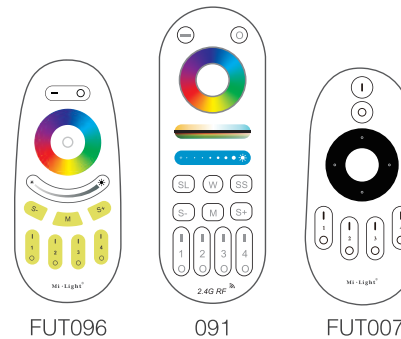

Suggestion: Complete the network distribution of the equipment first, then adjust the output mode Pilot lamp.

Indicating light instruction:

Red light always-on	Green light always-on	Red light blinking	Blue light always-on
Disconnected from network	Networking successfully	Waiting for smart link	WiFi router disconnected but still controllable

3. Auto-synchronization function

Different controllers can work synchronously when they are started at different times, controlled by the same remote, under same dynamic mode and with same speed.

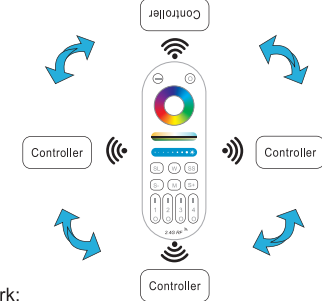

Remark:

1. Indicating Auto-transmitting.
2. Controller will be auto-synchronizing in the same dynamic modes and within 30m controlling distance.

Switching Bluetooth control steps:

- (1) Complete the network distribution of the equipment.
- (2) Power off the router used for network configuration, turn off WiFi on the mobile phone, turn on Bluetooth, and wait for about 3-5 minutes to control.

8. Free screw when connecting to LED strip

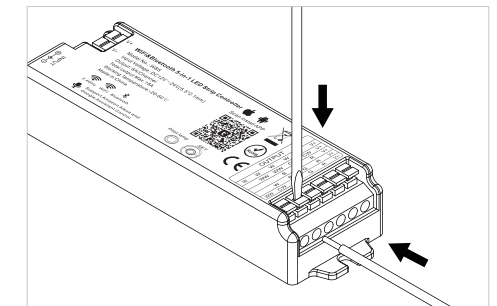

7. Bluetooth control instructions

When the router is disconnected, you can turn on the Bluetooth of your smartphone and connect directly controlled device at a short distance.

≥0.39 in / 10mm

Tuya Smart Life APP WiFi Control Instruction:

1,Download and install [Tuya Smart] APP or [Smart Life] APP

Search for [Smart Life] in Apple or Google store or scan following QR code to download and install the app.

Please click "Register" button to create account while using it in the first time, Log in directly if you already had account.



2, Connect to Smartphone

(1) Connect controller with power supply.

(2) Confirm Pilot lamp is flashing quickly (2 flashes per second)

If Pilot lamp isn't in fast flashing state, there are two ways to enter:

- Long press "SET" key until Pilot lamp flashing quickly.
- Power OFF and ON once, long press Zone ON button of linked remote until the LED strip blinking 3 times.(available remote model: LM091)

(3) Connect phone with home WiFi network in the 2.4GHz frequency.

(4) Open homepage of APP and click "+" button at the upper right corner of page.If the pilot lamp is flashing red, it will find the new device automatically.

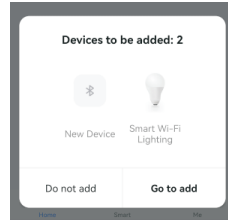

(5) Added devices will be displayed on home page after network configuration is successful.

(6) Click device you want to control to enter the control interface.



3,APP Control

(1) Click "device" or "group" you want to control on homepage to enter control page, where you can control color, saturation, brightness, color temperature, and scene.

(2) Click music sync to enter music rhythm mode, light will change with rhythm of music.

Note: Music rhythm mode requires phone keep on this page

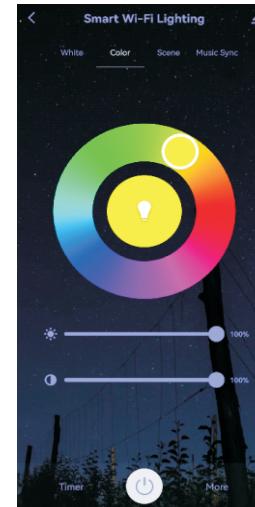

(3)Click More on the right bottom, you can choose more settings, including Plan, Schedule,Biorhythm and Power-on behavior.

Detailed setting, please read the below links:

<https://developer.tuya.com/en/docs/iot/product-panel-configuration?id=K9s9rhj4i7z8b#title-11-生物节律>

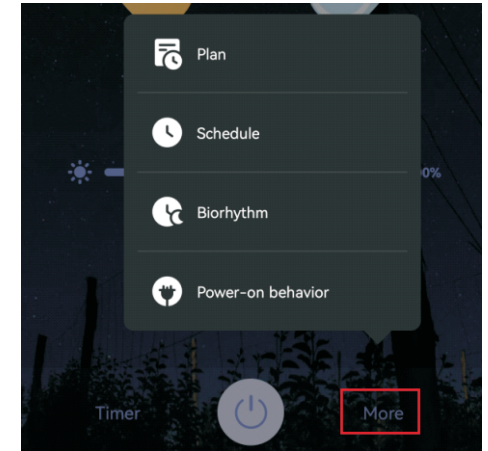

4,Device name editing, third-party control, device sharing, group control.

(1) Click "+" on the upper right corner of control page to enter edit page, where you can modify device name, icon, etc.

(2)Click icon under third-party control to view detailed description of third-party control.

(3) Click "Share Device" to share device with family and friends.

(4) Click "Create Group" and follow APP prompt after setting is completed, the device can be controlled by group.

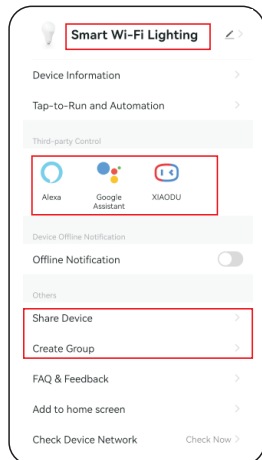

5 Intelligent control

(1) Click "Smart" at the bottom.

(2) Click "+" in the upper right corner to create intelligent control.

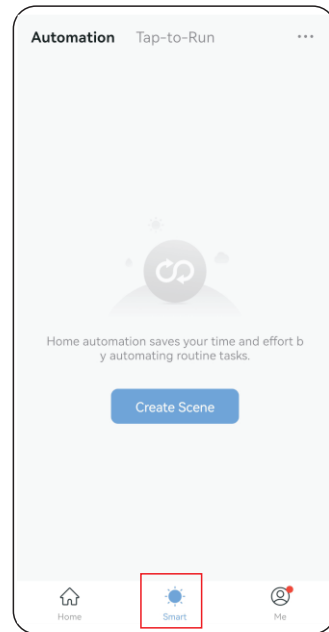

(3) In the page of creating smart, you can set command to be executed under the specified conditions (such as: turn on or turn off light, color, brightness, mode, etc.)

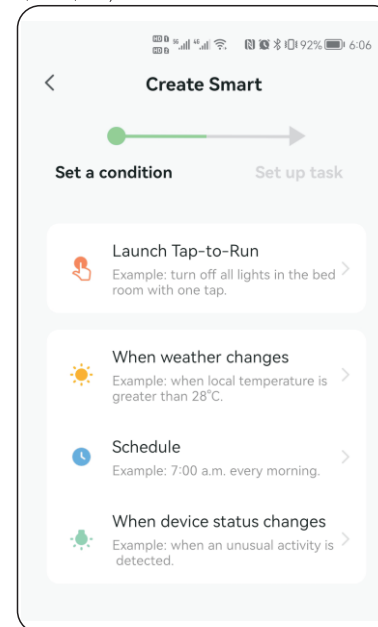

Attention

1. Please check whether the input voltage of the constant voltage power supply is in accordance with the controller, and please check the connection of both the cathode and anode.
2. The working Voltage is DC12~24V,the controller will be broken if the voltage is higher than 24V.
3. Non-professional user cannot dismantle the controller directly, otherwise, it may cause fire and electric shock.
4. The working temperature is 20~60°C; Do not use the device to direct sunlight, moist and other high temperature area.
5. Please do not use controller around the mental area and high magnetic field, otherwise,it will badly affect the control distance.
- 6.When the device load to 15A,wire diameter must be over 1.5mm²



Made in China